

PCM 90
Digital
Reverberator User Guide

lexicon

Unpacking and Inspection

After unpacking the PCM 90, save all packing materials in case you ever need to ship the unit. Thoroughly inspect the PCM 90 and packing materials for signs of damage. Report any shipment damage to the carrier at once; report equipment malfunction to your dealer.

Precautions

Save these instructions for later use.

Follow all instructions and warnings marked on the unit.

Always use with the correct line voltage. Refer to the manufacturer's operating instructions for power requirements. Be advised that different operating voltages may require the use of a different line cord and/or attachment plug.

Do not install the unit in an unventilated rack, or directly above heat producing equipment such as power amplifiers. Observe the maximum ambient operating temperature listed in the product specification.

Slots and openings on the case are provided for ventilation; to ensure reliable operation and prevent it from overheating, these openings must not be blocked or covered. Never push objects of any kind through any of the ventilation slots. Never spill a liquid of any kind on the unit.

This product is equipped with a 3-wire grounding type plug. This is a safety feature and should not be defeated.

Never attach audio power amplifier outputs directly to any of the unit's connectors.

To prevent shock or fire hazard, do not expose the unit to rain or moisture, or operate it where it will be exposed to water.

Do not attempt to operate the unit if it has been dropped, damaged, exposed to liquids, or if it exhibits a distinct change in performance indicating the need for service.

This unit should only be opened by qualified service personnel. Removing covers will expose you to hazardous voltages.

This triangle, which appears on your component, alerts you to the presence of uninsulated, dangerous voltage inside the enclosure... voltage that may be sufficient to constitute a risk of shock.



This triangle, which appears on your component, alerts you to important operating and maintenance instructions in this accompanying literature.

Notice

This equipment generates and uses radio frequency energy and if not installed and used properly, that is, in strict accordance with the manufacturer's instructions, may cause interference to radio and television reception. It has been type tested and found to comply with the limits for a Class B computing device in accordance with the specifications in Subpart J of Part 15 of FCC Rules, which are designated to provide reasonable protection against such interference in a residential installation. However, there is no guarantee that interference will not occur in a particular installation. If this equipment does cause interference to radio or television reception, which can be determined by turning the equipment OFF and ON, the user is encouraged to try to correct the interference by one or more of the following measures:

- Reorient the receiving antenna
- Relocate the computer with respect to the receiver
- Move the computer away from the receiver
- Plug the computer into a different outlet so that the computer and receiver are on different branch circuits.

If necessary, the user should consult the dealer or an experienced radio/television technician for additional suggestions. The user may find the following booklet prepared by the Federal Communications Commission helpful:

"How to identify and Resolve Radio/TV Interference Problems."

This booklet is available from the U.S. Government Printing Office, Washington, DC 20402, Stock No. 004-000-00345-4.

Le présent appareil numérique n'émet pas de bruits radioélectriques dépassant les limites applicables aux appareils numériques de la class B prescrites dans le Règlement sur le brouillage radioélectrique édicté par le ministère des Communications du Canada.

Copyright ©1997
All Rights Reserved.

Lexicon Part # 070-10399 Rev 1

PCM 90
Digital
Reverberator User Guide

lexicon

Dansk

Vigtig information om sikkerhed

Gem denne vejledning til senere brug.

Følg alle anvisninger og advarsler på apparatet.

Apparatet skal altid tilsluttes den korrekte spænding. Der henvises til brugsanvisningen, der indeholder specifikationer for strømforsyning. Der gøres opmærksom på, at ved varierende driftsspændinger kan det blive nødvendigt at bruge andre lednings- og/eller stiktyper.

Apparatet må ikke monteres i et kabinet uden ventilation eller lige over andet udstyr, der udvikler varme, f.eks. forstærkere. Den maksimale omgivelsestemperatur ved drift, der står opført i specifikationerne, skal overholdes.

Der er ventilationsåbninger i kabinettet. For at sikre apparatets drift og hindre overophedning må disse åbninger ikke blokeres eller tildækkes. Stik aldrig noget ind gennem ventilationsåbningerne, og pas på aldrig at spilde nogen form for væske på apparatet.

Dette apparat er forsynet med et stik med jordforbindelse. Denne sikkerhedsforanstaltning må aldrig omgås.

Udgangsstik fra audioforstærkere må aldrig sættes direkte i apparatet.

Apparatet må ikke udsættes for regn eller fugt og må ikke bruges i nærheden af vand for at undgå risiko for elektrisk stød og brand.

Apparatet må aldrig bruges, hvis det er blevet stødt, beskadiget eller vådt, eller hvis ændringer i ydelsen tyder på, at det trænger til eftersyn.

Dette apparat må kun åbnes af fagfolk. Hvis dækslet tages af, udsættes man for livsfarlig højspænding.



Denne mærkat på komponenten advarer om uisoleret, farlig spænding i apparatet ... høj nok til at give elektrisk stød.



Denne mærkat på komponenten advarer om vigtig drifts- og vedligeholdelsesinformation i den tilhørende litteratur.

Suomi

Tärkeitä turvallisuusohjeita

Säilytä nämä ohjeet tulevaa käyttöä varten.

Seuraa kaikkia yksikköön merkittyjä ohjeita ja varoituksia.

Käytä aina oikeaa verkkojännitettä. Tehovaatimukset selviävät valmistajan käyttöohjeista. Huomaa, että eri käyttöjännitteet saattavat vaatia toisenlaisen verkkojohdon ja/tai -pistokkeen käytön.

Älä asenna yksikköä telineeseen jossa ei ole tuuletusta, tai välittömästi lämpöä tuottavien laitteiden, esim. tehovahvistimien, yläpuolelle. Ympäristön lämpötila käytössä ei saa ylittää tuotespesifikaation maksimilämpötilaa.

Kotelo on varustettu tuuletusreiillä ja -aukoilla. Luotettavan toiminnan varmistamiseksi ja ylläpennemisen välttämiseksi näitä aukkoja ei saa sulkea tai peittää. Mitään esineitä ei saa työntää tuuletusaukoihin. Mitään nesteitä ei saa kaataa yksikköön.

Tuote on varustettu 3-johtimisella maadoitetulla verkkopistokkeella. Tämä on turvallisuustoiminne eikä sitä saa poistaa.

Älä kytkä audiotehovahvistimen lähtöjä suoraan mihinkään yksikön liittimeen.

Sähköiskun ja palovaaran välttämiseksi yksikkö ei saa olla sateessa tai kosteassa, eikä sitä saa käyttää määrässä ympäristössä.

Älä käytä yksikköä jos se on pudonnut, vaurioitunut, kostunut, tai jos sen suorituskkyky on huomattavasti muuttunut, mikä vaatii huoltoa.

Yksikön saa avata vain laitteeseen perehtynyt huoltohenkilö. Kansien poisto altistaa sinut vaarallisille jännitteille.



Tämä kolmio, joka esiintyy komponentissasi, varoittaa sinua eristämättömän vaarallisen jännitteen esiintymisestä yksikön sisällä. Tämä jännite saattaa olla riittävän korkea aiheuttamaan sähköiskuvaaran.



Tämä kolmio, joka esiintyy komponentissasi, kertoo sinulle, että tässä tuotedokumentoinnissa esiintyy tärkeitä käyttö- ja ylläpito-ohjeita.

Norsk

Viktig informasjon om sikkerhet

Ta vare på denne veiledningen for senere bruk.

Følg alle anvisningene og advarslene som er angitt på apparatet.

Apparatet skal alltid anvendes med korrekt spenning. Produktbeskrivelsen inneholder spesifikasjoner for strømkrav. Vær oppmerksom på at det ved ulike driftsspenninger kan være nødvendig å bruke en annen ledning- og/eller støpseltype.

Apparatet skal ikke monteres i skap uten ventilasjon, eller direkte over varmeproduerende utstyr, som for eksempel kraftforstærkere. Den maksimale romtemperaturen som står oppgitt i produktbeskrivelsen, skal overholdes.

Apparatet er utstyrt med ventilasjonsåpninger. For at apparatet skal være pålitelig i bruk og ikke overopphetes, må disse åpningene ikke blokeres eller tildekkes. Stikk aldri noe inn i ventilasjonsåpningene, og pass på at det aldri søles noen form for væske på apparatet.

Dette apparatet er utstyrt med et jordet støpsel. Dette er en sikkerhetsforanstaltning som ikke må forandres.

Utgangspluggen fra audioforstærkere skal aldri koples direkte til apparatet.

Unngå brannfare og elektrisk støt ved å sørge for at apparatet ikke utsettes for regn eller fuktighet og ikke anvendes i nærheten av vann.

Apparatet skal ikke brukes hvis det har blitt utsatt for støt, er skadet eller blitt vått, eller hvis endringer i ytelsen tyder på at det trenger service.

Dette apparatet skal kun åpnes av fagfolk. Hvis dekslet fjernes, utsettes man for livsfarlig høyspenning.



Komponenten er merket med denne trekanten, som er en advarsel om at det finnes uisolert, farlig spenning inne i kabinettet ... høy nok til å utgjøre en fare for elektrisk støt.



Komponenten er merket med denne trekanten, som betyr at den tilhørende litteraturen inneholder viktige opplysninger om drift og vedlikehold.

Svenska

Viktiga säkerhetsföreskrifter

Spara dessa föreskrifter för framtida bruk.

Följ alla anvisningar och varningar som anges på enheten.

Använd alltid rätt nätspänning. Se tillverkarens bruksanvisningar för information om effektkrav. Märkväl, att andra matningsspänningar eventuellt kräver att en annan typs nätsladd och/eller kontakt används.

Installera inte enheten i ett oventilerat stativ, eller direkt ovanför utrustningar som avger värme, t ex effektförstärkare. Se till att omgivningens temperatur vid drift inte överskrider det angivna värdet i produktspecifikationen.

Behållaren är försedd med håll och öppningar för ventilering. För att garantera tillförlitlig funktion och förhindra överhettning får dessa öppningar inte blockeras eller täckas. Inga föremål får skuffas in genom ventilationshålen. Inga vätskor får spillas på enheten.

Produkten är försedd med en jordad 3-trådskontakt. Detta är en säkerhetsfunktion som inte får tas ur bruk.

Anslut aldrig audioeffektförstärkarutgångar direkt till någon av enhetens kontakter.

För att undvika elstöt eller brandfara får enheten inte utsättas för regn eller fukt, eller användas på ställen där den blir våt.

Använd inte enheten om den har fallit i golvet, skadats, blivit våt, eller om dess prestanda förändrats märkbart, vilket kräver service.

Enheten får öppnas endast av behörig servicepersonal. Farliga spänningar blir tillgängliga när locken tas bort.



Denna triangel, som visas på din komponent, varnar dig om en oisolerad farlig spänning inne i enheten. Denna spänning är eventuellt så hög att fara för elstöt föreligger.



Denna triangel, som visas på din komponent, anger att viktiga bruksanvisningar och serviceanvisningar ingår i dokumentationen i fråga.

Deutsch
Wichtige Sicherheitsanweisungen

Heben Sie sich diese Sicherheitsanweisungen auch für später auf. Befolgen Sie alle auf der Vorrichtung stehenden Anweisungen und Warnungen. Immer nur mit der richtigen Spannung verwenden! Die Gebrauchsanweisungen des Herstellers informieren Sie über die elektrischen Anforderungen. Vergessen Sie nicht daß bei verschiedenen Betriebsspannungen ggf. auch verschiedene Leitungskabel und/oder Verbindungsstecker zu verwenden sind.

Stellen Sie die Vorrichtung nicht in ein unbelüftetes Gestell oder unmittelbar über wärmeerzeugende Geräte wie z.B. Tonverstärker. Halten Sie die in den Produktspezifikationen angegebene maximale Umgebungstemperatur bei Betrieb ein.

Schlitze und Öffnungen im Gehäuse dienen der Belüftung; um verlässlichen Betrieb sicherzustellen und Überheizen zu vermeiden dürfen diese Öffnungen nicht verstopft oder abgedeckt werden. Stecken Sie nie irgend einen Gegenstand durch die Belüftungsschlitze. Vergießen Sie keine Flüssigkeiten auf den Apparat.

Dieses Produkt ist mit einem 3-drahtigen Erdungsstecker ausgerüstet. Diese Sicherheitsmaßnahme darf nicht unwirksam gemacht werden.

Schließen Sie nie Tonverstärker unmittelbar an einen Anschluß des Apparates an.

Um elektrischen Schlag oder Feuer zu vermeiden, setzen Sie den Apparat weder Regen noch Feuchtigkeit aus und betreiben Sie ihn nicht dort wo Wasser eindringen könnte.

Versuchen Sie nicht den Apparat zu betreiben falls er fallen gelassen, beschädigt, oder Flüssigkeiten ausgesetzt wurde, oder falls sich seine Arbeitsweise derart ändert daß daraus ein Bedarf nach Reparatur zu schließen ist.

Dieser Apparat sollte nur von qualifizierten Fachleuten geöffnet werden. Das Abnehmen von Abdeckungen setzt Sie gefährlichen Spannungen aus.



Dieses Dreieck auf Ihrem Apparat warnt Sie vor nicht-isolierter, gefährlicher Spannung im Gehäuse ... stark genug um eine Berührungsfahrgefahr darzustellen.



Dieses Dreieck auf Ihrem Apparat bedeutet daß wichtige Betriebs- und Wartungsanweisungen in der mitgelieferten Dokumentation zu finden sind.

Español
Instrucciones importantes de seguridad

Guarde estas instrucciones para uso posterior.

Utilice siempre el voltaje correcto. Dirijase a las instrucciones de operación del fabricante para obtener las especificaciones de potencia. Está al tanto de que voltajes de operación distintos requieren el uso de cables y/o enchufes distintos.

No instale esta unidad en un estante sin ventilación, ni tampoco directamente encima de equipos que generen calor tales como amplificadores de potencia. Fijese en las temperaturas ambientales máximas de operación que se mencionan en las especificaciones del producto.

Las aperturas y ranuras del chasis sirven para proveer la ventilación necesaria para operar la unidad con seguridad y para prevenir sobrecalentamiento, y por lo tanto no pueden ser obstruidas o cubiertas. No introduzca objetos de ningún tipo a través de las ranuras de ventilación, y nunca deje caer ningún líquido sobre la unidad.

Este producto está equipado con un enchufe de 3 clavijas con conexión a tierra. Éste es un elemento de seguridad que no debe ser eliminado.

Nunca conecte ningún tipo de salida de amplificadores de sonido directamente a los conectores de la unidad.

Para prevenir descargas eléctricas o incendios, mantenga la unidad alejada de la lluvia, humedad o cualquier lugar en el que pueda entrar en contacto con agua.

No trate de hacer funcionar la unidad si se ha caído, está dañada, ha entrado en contacto con líquidos, o si nota cualquier cambio brusco en su funcionamiento que indique la necesidad de hacerle un servicio de mantenimiento.

Esta unidad deberá ser abierta únicamente por personal calificado. Si usted quita las coberturas se expondrá a voltajes peligrosos.



Este triángulo que aparece en su componente le advierte sobre la existencia dentro del chasis de voltajes peligrosos sin aislantes ... voltajes que son lo suficientemente grandes como para causar electrocución.



Este triángulo que aparece en su componente lo alerta sobre las instrucciones de operación y mantenimiento importantes que están en los materiales de lectura que se incluyen.

Français
Instructions de Sécurité Importantes

Gardez ces instructions pour référence future.

Observez toutes les instructions et tous les avertissements marqués sur l'appareil.

Branchez uniquement sur un réseau de tension indiquée. Consultez le manuel d'instruction du fabricant pour les spécifications de courant. N'oubliez pas que différentes tensions peuvent nécessiter l'utilisation de câbles et/ou de fiches de connexion différents.

N'installez pas l'appareil en un compartiment non-aéré ou directement au-dessus d'équipements générateurs de chaleur, tels qu'amplificateurs de courants, etc. Ne dépassez pas la température ambiante maximale de fonctionnement indiquée dans les spécifications du produit.

Des fentes et ouvertures sont prévues dans le boîtier pour l'aération; Pour assurer le bon fonctionnement et pour prévenir l'échauffement, ces ouvertures ne doivent pas être couvertes ou bloquées. N'insérez pas d'objets dans les fentes d'aération. Empêchez tout liquide de se répandre sur l'appareil.

Ce produit est muni d'une fiche à trois fils pour la mise à terre. Ceci est une mesure de sécurité et ne doit pas être contrariée.

Ne connectez jamais d'amplificateurs audio directement aux connecteurs de l'appareil.

Pour empêcher les chocs électriques et le danger d'incendie, évitez d'exposer l'appareil à la pluie ou à l'humidité, et ne le mettez pas en marche en un endroit où il serait exposé aux éclaboussures d'eau.

N'essayez pas de faire fonctionner l'appareil s'il est tombé à terre, a été endommagé, exposé à un liquide, ou si vous observez des différences nettes dans son fonctionnement, indiquant la nécessité de réparations.

Cet appareil ne doit être ouvert que par un personnel de service qualifié. En enlevant les couvercles vous vous exposez à des tensions électriques dangereuses.



Ce triangle, sur votre appareil vous avertit de la présence de tension dangereuse, non-isolée à l'intérieur du boîtier...une tension suffisante pour représenter un danger d'électrocution.



Ce triangle sur sur votre appareil vous invite de suivre d'importantes instructions d'utilisation et d'entretien dans la documentation livrée avec le produit.

Italiano
Importanti norme di sicurezza

Conservare le presenti norme per l'utilizzo futuro.

Osservare tutte le istruzioni e le avvertenze apposte sull'unità.

Utilizzare esclusivamente con la tensione di rete corretta. Consultare le istruzioni operative fornite dal fabbricante per i dati riguardanti la tensione e l'assorbimento di corrente. Potrebbe essere necessario l'uso di cavi di rete e/o di spine diverse a seconda della tensione utilizzata.

Non installare l'unità in uno scaffale privo di ventilazione oppure direttamente sopra una fonte di calore, come, ad esempio, un amplificatore. Non superare la temperatura ambientale massima di funzionamento riportata nei dati tecnici del prodotto.

Le fessure e le altre aperture nella scatola servono alla ventilazione. Per un funzionamento affidabile, e per evitare un eventuale surriscaldamento, queste aperture non vanno ostruite o coperte in nessun modo. Evitare in tutti i casi di inserire oggetti di qualsiasi genere attraverso le fessure di ventilazione. Non versare mai del liquido di nessun tipo sull'unità.

Questo prodotto viene fornito con una spina a 3 fili con massa. Tale dispositivo di sicurezza non va eliminato.

Evitare sempre di collegare le uscite dell'amplificatore audio direttamente ai connettori dell'unità.

Per prevenire il pericolo di folgorazione e di incendio non esporre l'unità alla pioggia o ad un'umidità eccessiva; evitare di adoperare l'unità dove potrebbe entrare in contatto con acqua.

Evitare di adoperare l'unità se la stessa è stata urtata violentemente, se ha subito un danno, se è stata esposta ad un liquido o in caso di un evidente cambiamento delle prestazioni che indichi la necessità di un intervento di assistenza tecnica.

Ogni intervento sull'unità va eseguito esclusivamente da personale qualificato. La rimozione della copertura comporta l'esposizione al pericolo di folgorazione.



Il presente triangolo impresso sul componente avverte della presenza di tensioni pericolose non isolate all'interno della copertura... tali tensioni rappresentano un pericolo di folgorazione



Il presente triangolo impresso sul componente avverte l'utente della presenza nella documentazione allegata di importanti istruzioni relative al funzionamento ed alla manutenzione.

Contents

Introduction

1. Product Overview

Block Diagram	1-1
Front Panel Overview	1-2
Rear Panel Overview	1-3
Installation Notes	1-4
Mounting	1-4
Power Requirements	1-4
Audio Connections	1-4
Control Connections	1-4
Setting Audio Levels	1-5
Headroom Display • Overload • Setting Input Levels	
Setting Analog Output Level	
Configurations	1-7
Memory Cards	1-8

2. Basic Operation

Modes of Operation	2-1
Navigating a Matrix	2-2
Info	2-3
History of Effects Loaded	2-3
Control Mode	2-4
Program and Register Banks	2-17
Tempo Mode	2-20
Editing an Effect	2-23
The Soft Knob	2-23
The Soft Row	2-24
Compare	2-25
Bypass	2-25
Store operations	2-26
Turning Memory Protection On • Storing an Effect	
Renaming the Effect • Selecting a Bank and Register	
Location	
The Full Edit Matrix	2-28
Creating a Soft Row	
Patching	2-31
About Sources • The Patch Row • Assigning a Source	
Patch Sources • Assigning a Destination • Assigning	
Values • Jump	
Patching Examples	2-35
Creating a patch with default values • Adjusting the	
modulation source parameters • Changing the default	
destination values • Adding an additional pivot point to	
the patch • Multiple Patches with the Same Destination	
Mod Row Patches	
The Custom Row	2-42
Setting Range Limits for ADJUST and the Custom	
Controls • Labeling ADJUST, the Custom Controls and Their	
Ranges • Assigning KeyWords to an Effect	

Contents, cont'd. 3. The Algorithms and their Parameters

About the Algorithms	3-1
Random Hall	3-2
Ambience	3-4
Rich Plate	3-5
Concert Hall	3-6
Chamber/Room	3-7
The Parameters	3-8
Compress	3-8
Controls	3-9
Custom	3-10
Delay	3-12
Design	3-12
Echo	3-14
Expand	3-14
Modulation	3-15
Patches	3-20
Reflect	3-21
Spatial EQ	3-21
Time	3-22

4. The Presets

Program Bank 0 Halls	4-2
Orchestral (0.0-0.9)	4-2
Vocal (1.0-1.9)	4-3
Live Sound (2.0-2.9)	4-4
Instrument (3.0-3.9)	4-5
Custom (4.0-4.9)	4-6
Program Bank 1 Rooms	4-7
Instrument (0.0-0.9)	4-7
Vocal (1.0-1.9)	4-8
Live Sound (2.0-2.9)	4-9
Drums&Perc (3.0-3.9)	4-10
Custom (4.0-4.9)	4-11
Program Bank 2 Plates	4-12
Instrument (0.0-0.9)	4-12
Vocal (1.0-1.9)	4-13
Live Sound (2.0-2.9)	4-14
Drums&Perc (3.0-3.9)	4-15
Custom (4.0-4.9)	4-16
Program Bank 3 Post	4-17
Indoor Small (0.0-0.9)	4-17
Indoor Large (1.0-1.9)	4-18
Outdoor (2.0-2.9)	4-19
Spatial (3.0-3.9)	4-19
Custom (4.0-4.9)	4-21
Program Bank 4 Splits	4-22
Mono (0.0-0.9)	4-22
Stereo (1.0-1.9)	4-23
Live Sound (2.0-2.9)	4-24
Instrument (3.0-3.9)	4-25
Custom (4.0-4.9)	4-26

- 5. MIDI Operation**
 - Selecting a MIDI Channel 5-1
 - Accessing Programs and Registers 5-1
 - Controlling PCM 90 Tempo Rate with MIDI Clock 5-2
 - MIDI Tempo Control 5-2
 - Using the PCM 90 as a MIDI Clock Source 5-2
 - Slaving two or more PCM 90s 5-3
 - Controller Quirks 5-4
 - The ADJUST Knob, Custom Controls, Foot Pedal, Foot Sw 1
and Foot Sw 2 as MIDI controllers 5-4
 - Controlling the Soft Knob with MIDI 5-5
 - Controlling the Soft Knob with a Foot Pedal 5-5
 - Program Change Messages 5-6
 - Automation 5-7
 - SysEx Automation • Controller Automation • Reset All
Controllers • MIDI Clock and Clock Commands • Dynamic
MIDI®
 - Bulk Data Dumps 5-8
 - MIDI Implementation Chart 5-9

- 6. Troubleshooting**
 - Low Voltage 6-1
 - Overheating 6-1
 - Common MIDI Problems 6-1
 - Operational Problems 6-2
 - Power On Behavior 6-3
 - Restoring Factory Default Settings 6-3
 - Reinitialization 6-4

- 7. Specifications**

Thank you for your purchase of the PCM 90 Digital Reverberator. The PCM 90 gives you Lexicon's renowned high-end reverb effects with a powerful new interface that provides easy access to superbly crafted presets as well as a wealth of programming capabilities for the sound designer.

Introduction

The PCM 90 contains a built-in library of 250 reverb effects that simulate realistic halls, rooms and plates, and let you create completely natural, or other-worldly spaces. The presets are organized into 5 Banks of 50, and are functionally grouped for different applications. Be sure to experiment with all 250 presets to get a feel for the full range of PCM 90 capabilities.

The Presets

Bank P0 Halls 0.0-0.9 Orchestral 1.0-1.9 Vocal 2.0-2.9 Live Sound 3.0-3.9 Instrument 4.0-4.9 Custom	Bank P1 Rooms 0.0-0.9 Instrument 1.0-1.9 Vocal 2.0-2.9 Live Sound 3.0-3.9 Drums&Perc 4.0-4.9 Custom	Bank P2 Plates 0.0-0.9 Instrument 1.0-1.9 Vocal 2.0-2.9 Live Sound 3.0-3.9 Drums&Perc 4.0-4.9 Custom	Bank P3 Post 0.0-0.9 Indoor Small 1.0-1.9 Indoor Large 2.0-2.9 Outdoor 3.0-3.9 Spatial 4.0-4.9 Custom	Bank P4 Splits 0.0-0.9 Mono 1.0-1.9 Stereo 2.0-2.9 Live Sound 3.0-3.9 Instrument 4.0-4.9 Custom
---	---	--	---	---

A program sorting function allows you to tag programs with *KeyWords* and display only programs which have been tagged. (Press **Program Banks** or **Register Banks** repeatedly to step through all available banks and then to the KeyWord display.) The default KeyWord selection, **A to Z**, allows you to view all of the presets in alphabetical order. Others allow you to view, for example, only **Acoustic** or **Spatial** effects. Each preset has already been assigned from 1 to 4 KeyWords — you can easily change these assignments in Edit mode. The selection of the KeyWord you want to use for sorting is accessed in Control mode.

Program Sorting

Each preset has one or more of its parameters patched to the front panel ADJUST knob, giving you instant control over the primary aspect of the effect — without going into Edit mode.

Soft Control

As many as four additional *Custom Controls* can be created for any effect, allowing you to tailor presets for specific applications. We've created some interesting Custom Controls in the presets, and assigned them descriptive names. You can change both the parameter assignments and the names in Edit mode.

The PCM 90 uses 5 stereo algorithms to create different types of reverb effects. Each algorithm includes an uncompromised stereo reverb effect with selected "tools" for ambience, post-processing, compression/expansion, as well as modulation and patching parameters which are common to each algorithm.

The Algorithms

Tempo Control The PCM 90 gives you a unique set of tempo controls. Tempos can be tapped in with the front panel Tap button (or an assigned controller) or “dialed-in”, in BPM (beats per minute) on the display. The PCM 90 also lets you generate MIDI clock from your tempo, as well as receive MIDI tempo from an external sequencer or drum machine. In the PCM 90, tempo can control LFO speeds and Time Switch controls, as well as all delay parameters, ensuring that all of your modulations are in tempo with your music. You can even set independent rhythmic values for different parameters within a single program.

Tempo can be set and displayed in either rhythmic value or time values. Many presets have delay times assigned to Tap tempo. Try loading some of these and pressing **Tap** twice in rhythm to change tempo.

Editing An enormous range of editing control is provided for each algorithm, with parameters organized in an edit matrix. In addition to providing this powerful sound design capability, the PCM 90 also allows you to customize these controls for your day-to-day editing needs, or to use a subset of controls specially designed for each preset.

The PCM 90 has two levels of Edit Mode control called **Go** mode and **Pro** mode. In **Go** mode, the most useful parameters within an effect are grouped for instant access via the front panel Edit button. Parameters can even be grouped for control by a single master control. These master parameters, called Custom Controls, can be labeled with names that describe their function. Each preset has a specially selected set of **Go** mode parameters which let you make value changes to the effect without losing the character of the sound. **Pro** mode gives you access to the full parameter editing matrix for the algorithm of any loaded effect when you press Edit. In this mode, you can access a complete set of Modulation and Patching parameters, create your own ADJUST knob patch, create Custom Controls, and assign your own **Go** mode parameters.

A unique Patching and Modulation system provides unprecedented control over your effects, with a versatile set of internal modulators: two LFOs, AR Envelope, Envelope Follower, Latch and Time Switches, MIDI Delay and Sample and Hold. These allow you to create modulation sweeps which move in time with music, or animated effects. You can create as many as 10 patches per effect, each with as many as 8 pivot points. You can patch multiple parameters to a single controller, or patch multiple sources to a single destination.

User Interface For all of its programming power and flexibility, you'll find the PCM 90 simple to use. The large, 2-line fluorescent display is easy to see from any angle whether the surroundings are bright or dark. Separate SELECT and ADJUST knobs make program loading and editing quick and easy. We've even designed in a special Info mode — press and hold any button to find out what its function is, or to get status information such as the name of the running effect, current tempo rate, etc.

To get the most out of the PCM 90, we suggest that you invest the time to explore this manual. We think you'll agree that the time spent investigating will reward you with enjoyment of its full capabilities.

Product Overview

Block Diagram

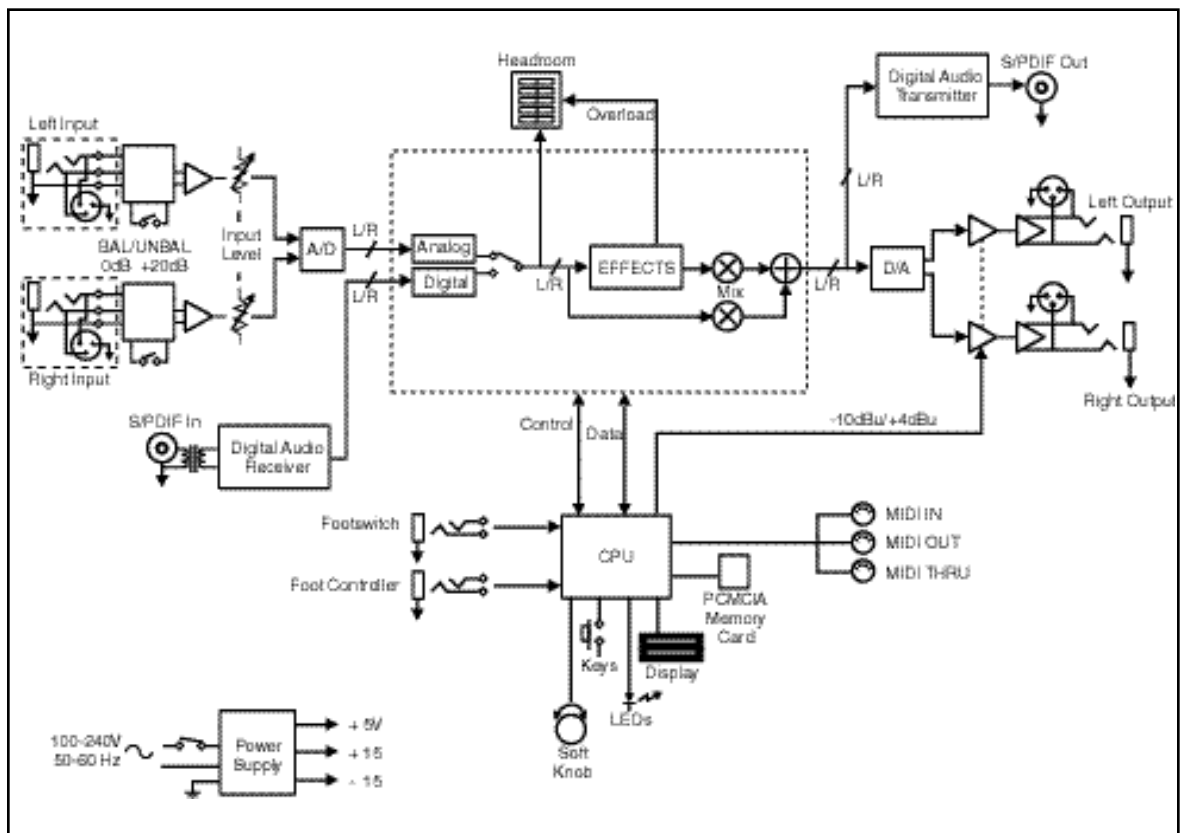

Front Panel Overview

HEADROOM

5-position indicator for analog and digital signal levels and overload conditions.

INPUT

Adjusts analog input level.

Display

Two rows of 20 alphanumeric characters display effect names and ID numbers, and parameter names and values.

ADJUST

In Edit mode, changes values of parameters chosen with SELECT. With Program Banks or Register Banks selected, behaves as a soft knob for patched parameters.

SELECT

Scrolls through presets, registers or parameters. With Program Bank or Register Bank selected, scrolls through the 50 programs in the selected bank, then begins scrolling through the programs in the next bank. With Edit selected, scrolls through matrix parameters.

POWER

On/Off.

Memory Card

Slot for optional preset ROM or register RAM cards. Press Eject button to remove card.



Up/Down

Press to move up and down through program and register banks, or a parameter matrix.

Program Banks

Enables selection of factory presets. Press repeatedly to cycle selection of 5 internal preset banks and a KeyWord sorted display. Press and hold to display the name and algorithm of the current program.

Load/★

In Program or Register mode, loads the selected program. In Edit mode, scrolls through any multi-field parameter.

Register Banks

Enables selection of user memory. If a RAM card is loaded into the Memory Card slot, each press of this button selects a new register bank. Press and hold to display the name and algorithm of the current program.

Store

Initiates register store function.

Edit

Enables parameter selection for editing of values.

Compare

Active in Program, Register, and Edit modes. Press to compare the active version of the current effect with the most recently stored version.

Control

Enables selection of system and global parameters.

Bypass

Bypasses or mutes audio, depending on the setting of each program's bypass parameter.

Tempo

Press to display tempo rate and to initiate tempo functions. LED flashes in time with current tempo rate.

Tap

Sets tempo. Press twice in rhythm to establish tempo rate. Press once to reset LFO.

Rear Panel Overview

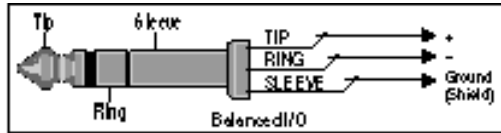

S/PDIF In/Out

S/PDIF format digital connectors conform to CP-340 Type II and IEC-958 consumer standards.

Balanced Outputs

Output impedance is 125Ω, each side, balanced, and levels up to +18dBu maximum full scale. 1/4" phone connectors and XLRs provided.

Input Level

2-position (In/Out) switch for matching input gain to the source being used. In position adds 20dB of input gain (unbalanced) to the input stages. Out position provides 0dB of gain (balanced).

Balanced Inputs

Combined 3 pole XLR and 1/4" jacks, electronically balanced.

Input impedance is 50kΩ unbalanced, and 100kΩ balanced. Inputs accept input levels from -22dBu to +20dBu.



AC Power

Standard 3-pin IEC power connector. 100-240V, 50-60Hz automatic switching to correct voltage range.

MIDI IN

Receives MIDI information from other MIDI equipment such as master keyboard controllers, MIDI foot controllers, sequencers and synthesizers.

THRU

Passes received MIDI data without change.

OUT

Transmits MIDI data to other equipment.

Footswitch

1/4" Tip/Ring/Sleeve phone jack for two independent momentary footswitches

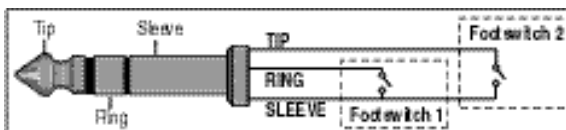

Foot Controller

1/4" Tip/Ring/Sleeve phone jack provided for footpedal with 10kΩ to 100Ω impedance.

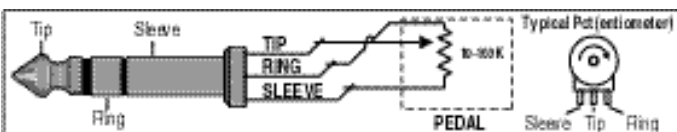

Installation Notes

Mounting The PCM 90 uses one EIA-standard rack space, and can be mounted on any level surface or in a standard 19 inch (483 mm) rack. If the PCM 90 is mounted in a rack or road case, support the rear of the chassis to prevent possible damage from mechanical shock and vibration.

The maximum ambient operating temperature is 104°F (40°C). Provide adequate ventilation if the PCM 90 is mounted in a closed rack with heat-producing equipment such as power amplifiers.

Power Requirements The PCM 90 is equipped with a 3-pin IEC power connector and detachable cord.

The PCM 90 will operate with power sources from 100 to 240 volts AC, 50-60Hz. Power switching to actual line voltage is automatic.

Audio Connections **Analog Audio**

For best performance, maintain balanced connections, and use high-quality, low-capacitance, twisted-shielded pair cable.

When connecting to single-ended, unbalanced devices, connect the low side to signal ground at the unbalanced piece of equipment. Output level does not change when connected to an unbalanced input.

Mono Applications

Use a Y-connector inserted at the analog inputs and outputs to have the signal summed to mono.

NOTE

Be careful to keep input and output to all channels wired consistently. Out-of-phase wiring can produce audible effects.

Digital Audio

S/PDIF (CP-340 Type II) Consumer Digital Audio I/O. 75Ω coaxial cable suited for digital audio or video signals is required. Audio grade cable is *not* suitable.

Control Connections **Dual Footswitch/Foot Controller**

One 1/4 inch T/R/S phone jack is provided for 2 momentary footswitches. Another 1/4 inch T/R/S phone jack is provided for a footpedal (minimum 100Ω to maximum 10kΩ impedance). Normally open or normally closed momentary switches are suitable. At power on, the PCM 90 assumes the switch is off. Use shielded, twisted-pair cable with shield connected to sleeve. See diagram on previous page.

MIDI

5-pin DIN connectors are provided for MIDI IN, THRU and OUT. Use standard 5-pin DIN MIDI cable assemblies, available from your local dealer.

The PCM 90, with both analog and digital input and output connections, requires some attention to proper setting of signal level.

Setting Audio Levels

Analog inputs are first gain-conditioned by the rear panel input gain switch, and then by the front panel INPUT knob. Proper setting of both the switch and knob are important for best performance of the A/D converter.

Analog and digital sources are selected in Control mode (**0.0 Audio Input Source**). The selections are: **Digital, Analog 48kHz** and **Analog 44.1kHz**.

Proper setting of Input level on the PCM 90 is dependent on:



- Proper signal level into the analog front end to avoid signals causing overload at the DSP input (rear panel Input Level button),
- Proper adjustment of the signal level into the analog-to-digital converter to optimize noise and avoid overload (front panel INPUT knob),
- Proper setting of signal level into the digital signal processor to optimize noise (**InLvl** parameter in each algorithm).

Headroom Display

The headroom display provides both headroom and overload information from a variety of measurement points. The meters display analog or digital input data, depending on the selected **Audio Input Source** (Control mode **0.0**).



The chart below illustrates the adjustment range that will set input levels for both balanced and unbalanced operation. When a choice can be made, it is best to operate at the higher amplitude end of the recommended range to optimize noise performance.

	 Unbalanced	 Balanced
overload:	>+20dBu	> 0dBu
acceptable:	+20dBu to -2dBu	0dBu to -22dBu
too low (noisy):	<-2dBu	<-22dBu

Overload

The 0db (overload) indicators will light under the following conditions:

- A/D overload
- overload at any point in effects processing
- input level within 1dB of maximum

For example, level buildup from certain reverberation modes can result in overload, even when the input A/D or digital receiver data stream is not at full scale. Such conditions are most often caused by a combination of extreme parameter settings. Adjusting parameter/level settings can eliminate these overload conditions.

Setting Input Levels

1. Press **Control**.
2. Press **Up** or **Down** until the leftmost digit in the lower lefthand corner of the display is **0**.
3. Turn SELECT to **0.0 Audio Input Source**.
4. Turn ADJUST to select **Analog: 48kHz** or **Analog: 44.1kHz**.
5. Adjust the front panel INPUT knob so that program material level peaks cause the headroom display to reach the top of the column *without* lighting the overload indicators. An occasional large signal peak causing momentary flashing of the overload indicator is acceptable in most instances, but should be validated by listening to the actual result.
6. Turn ADJUST to select **Dig:**. The display will show any valid digital format which is properly connected to the PCM 90 rear panel digital input.

Setting Analog Output Level

While still in Control mode, turn SELECT to **0.3 Output Level**. The Output Level parameter has two range positions. The appropriate position depends on the level handling capability of the device connected to the analog outputs. Devices capable of handling outputs with peak levels of 18dBu require setting **Output Level** to the **+4dBu** setting. Devices which cannot handle peak levels greater than +4dBu require the **-10dBu** setting.

Configurations

Connection to a mixing console's effects sends

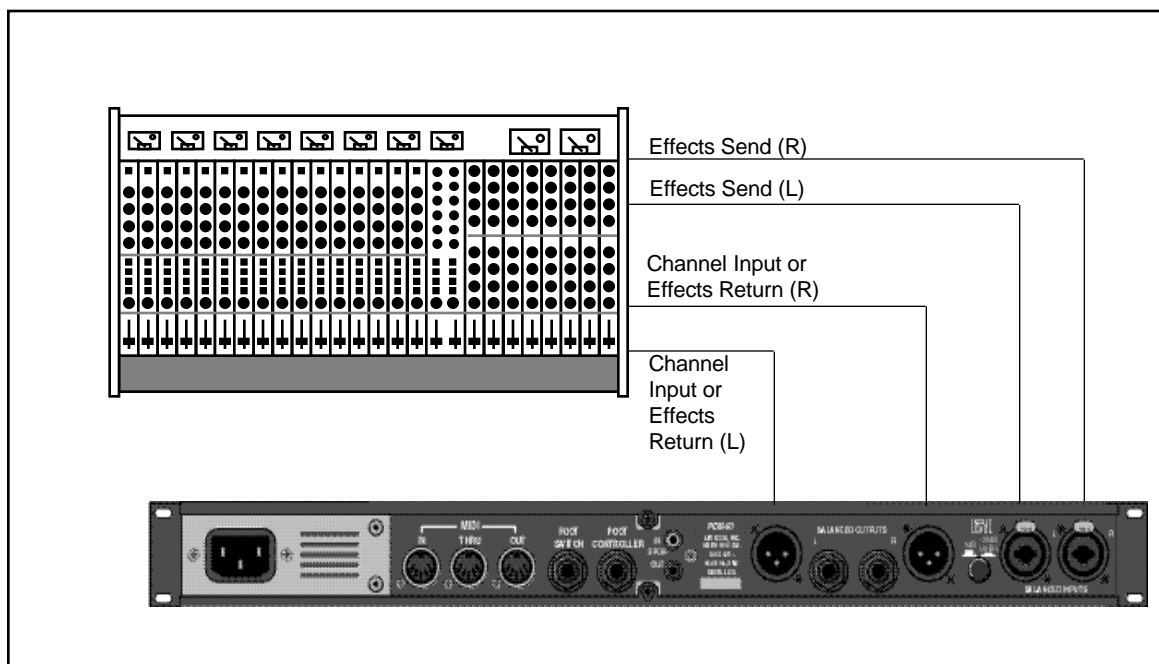

If you will be using a PCM 90 as your primary effects unit, and your system includes a console with one or more auxiliary (effects) sends, connect the PCM 90 as shown above. In most applications, it is preferable to connect the PCM 90 outputs to two of the console's input channel strips, panned full left and right, rather than to the effects returns. This allows the greatest flexibility in routing and equalization.

In this configuration the console controls are used to set the amount of effect heard—the PCM 90's MIX control should be set for 100% wet. To assign a global MIX setting:

1. Press **Control**.
2. Press **Up** or **Down** until **1.x** is displayed in the lower left of the display and **System** is displayed on the upper line.
3. Turn SELECT until **System Mix Mode** is displayed on the upper line. **1.1** will be displayed in the lower left.
4. Turn ADJUST until the lower line reads:
1.1 ✱ Global
5. Press **Load/✱** to show the current global setting of MIX; use ADJUST to set it to 100% wet.

Memory Cards

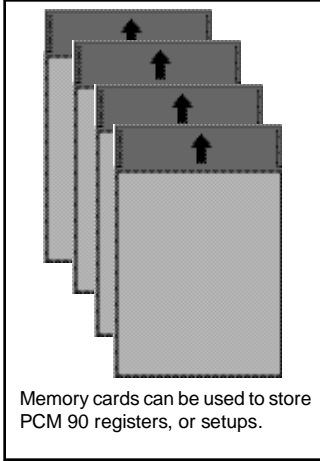

You can use Memory cards to store as many as 1000 PCM 90 registers (20 banks of 50 — on a 1 Meg card). Registers stored on a properly formatted card will be recognized whenever the card is inserted, and can be accessed via the front panel **Register Banks** button, exactly as internal registers.

Memory cards can also be used to store "setups" (your system configuration, as set in Control mode). As many as 5 PCM 90 setups can be stored on a card, allowing you to transport not only your effects, but complete PCM 90 environments to another PCM 90. Cards also provide storage for additional program maps and effect chains.

See *Control Mode* Store and Load functions for details on saving setups on a card and reloading them.

Memory cards must be of the following type:

PCMCIA SRAM Memory Card — 68 pin, Type I	
Usable densities:	64 kByte 128 kByte 256 kByte 1 MByte (Cards larger than 1MByte can be used, but the PCM 90 will only make use of 1MByte.)
Access Time:	250 nsec or faster
Conforms to PCMCIA 2.0/JEDIA 4.1. Can use either 8-bit or 8/16-bit bus configuration. Attribute memory can be present, but is not used.	

Basic Operation

The PCM 90 provides a wide range of control over an extraordinary set of reverb effects. All of the controls are easily accessed from the front panel and are described in detail in this section.

Modes of Operation

The PCM 90 has five basic modes of operation, each of which is selected by pressing a front panel button (**Program Banks**, **Register Banks**, **Edit**, **Control** and **Tempo**). Each of these first four mode buttons has an LED which lights when the mode is active. The Tempo LED (unless you elect to have this function turned off) flashes the current tempo. When Tempo mode is active, no other mode LEDs will be lighted.

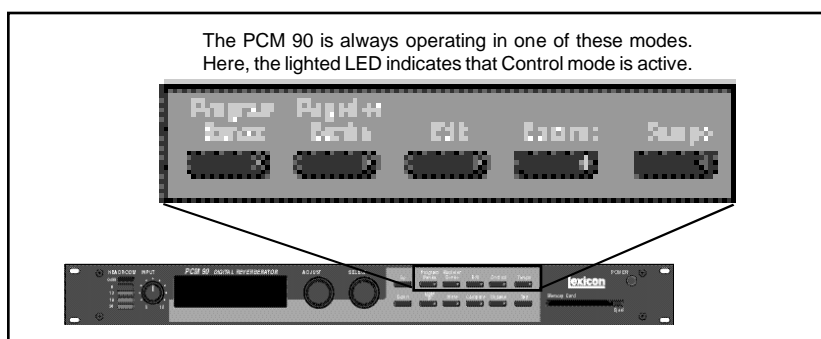

The five mode buttons give you the first level of access to all of the functions and parameters in the PCM 90.

- Press **Program Banks** repeatedly to access five banks of 50 factory presets and a KeyWord mode where programs can be viewed according to type. The PCM 90's KeyWord function is activated in Control mode.
- Press **Register Banks** repeatedly to access two banks of 50 memory locations, called *registers*, where you can store your customized effects. Memory cards can be used for storage of additional banks of registers. When a formatted memory card containing stored registers is inserted, pressing **Register Banks** repeatedly will cycle through both the internal and the card banks. Registers can be sorted and viewed according to type when the PCM 90's KeyWord function is activated in Control mode.
- Press **Edit** to access all of the available parameters for the currently running effect.
- Press **Control** to select system parameters, MIDI, card formatting, etc.
- Press **Tempo** to set tempo-related values that affect the delay time and LFO rate parameters of the currently-running effect.

Navigating a Matrix

All of the controls available in a mode are arranged in a matrix of up to 10 columns (numbered 0-9) and 10 rows (each numbered .0-.9). This arrangement allows any one of as many as 100 parameters to be selected simply by using the SELECT knob and the **Up** and **Down** buttons to select a position in the matrix.

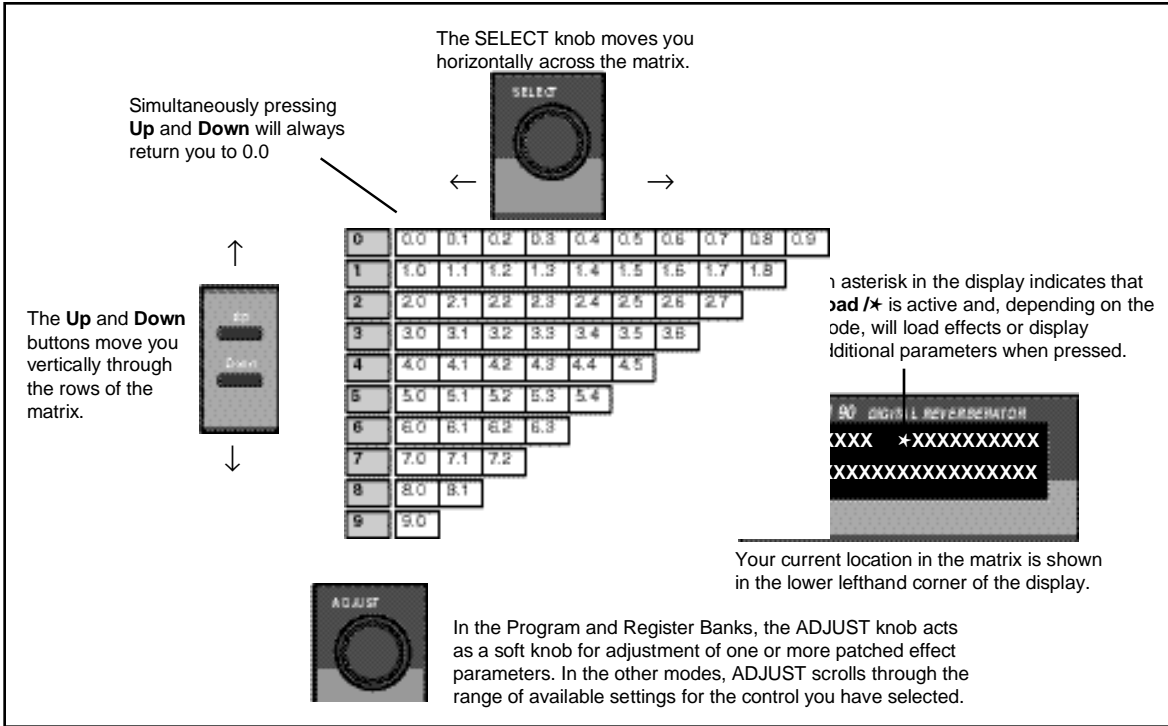

Go or Pro The PCM 90 offers a choice between two levels of Edit mode parameter access. We call these **Go** mode and **Pro** mode.

Go mode makes use of an extra row in the edit mode matrix called the Soft Row, where you can assign as many as 10 effect parameters or Custom Controls for easy access. Selecting **Go** mode (Control mode 1.0) limits the action of the **Edit** button to displaying only the Soft Row parameters assigned to the current effect.

Each preset has a set of Soft Row assignments which we've selected for you (as well as an assignment for the ADJUST knob and Custom Controls). When shipped, the PCM 90 will power up in **Go** mode with the first preset (P0 0.0) loaded. Press **Edit** to display the Soft Row of parameters. Press **Up** or **Down** to access a **Pro** mode selection display.

Pro mode gives you access to the full parameter matrix, including the Soft Row. Use this mode when you want to do in-depth effects editing or patching, or when you want to customize Soft Row assignments.

Go mode and **Pro** mode selection is made in Control mode at matrix location 1.0.

The PCM 90 offers an extensive set of informative display messages which can be activated from the front panel. **Info**

The front panel switches perform various functions when pressed. Most of these functions are activated on *release* of the button. If you want to know more about the function of a particular button (without actually executing any action) *press and hold* the button down. While you are holding down the button, an explanatory message will appear on the display. The activation of an Info message overrides the normal function of the button, so that no action is taken on release.

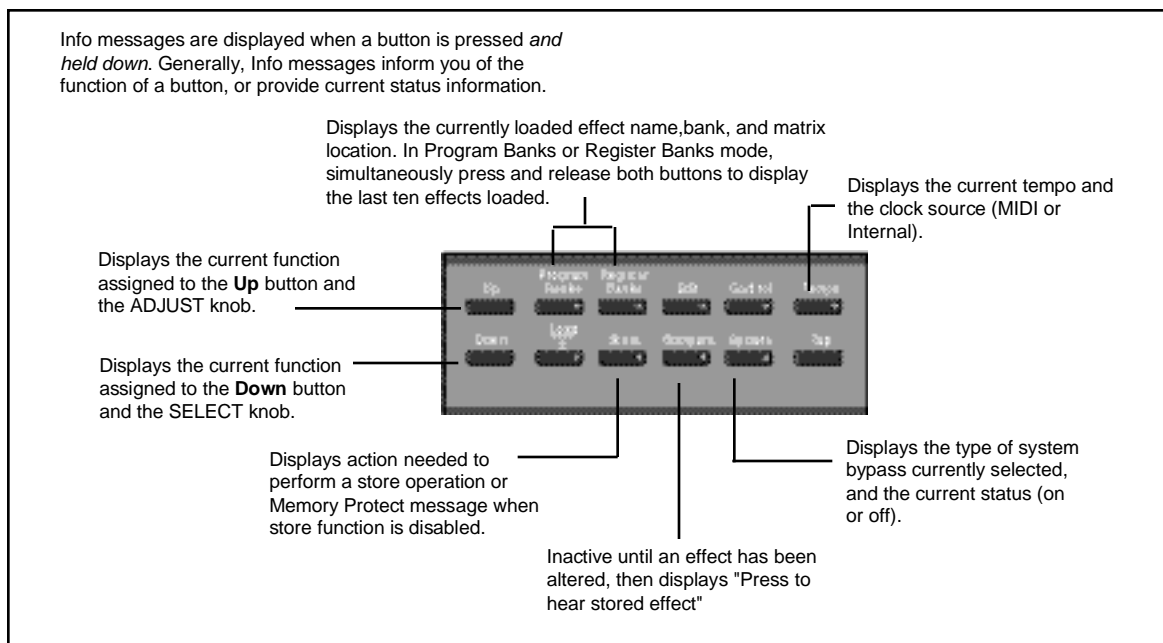

The PCM 90 allows you to review the last ten effects loaded. This is useful when you want to return to an effect you were using earlier, but can't remember its name or location. This History view is accessed from Program Banks or Register Banks mode by simultaneously pressing and releasing both the **Program Banks** and the **Register Banks** buttons. The following display will appear: **History of Effects Loaded**

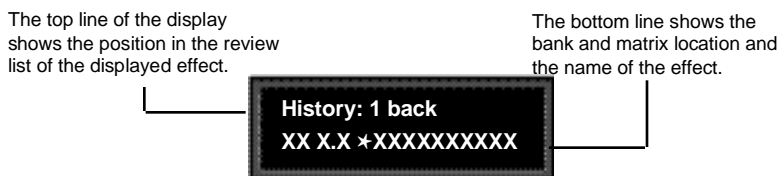

The label **1 back** in the example, means that the effect shown on the bottom line was running just before the current effect. Turning SELECT to the right will scroll you through the stored list of effects, all the way to **10 back**. Press **Load/*** to load any of the displayed programs. Press any key to exit.

Note that loading programs from the review display does not update the historical record, nor does loading from MIDI, Chain or Map. Only program loads from Programs Banks or Register Banks mode are recorded.

Control Mode Selections of various system states and conditions are made in Control Mode. Press **Control** to enter this mode. The Control button LED will light to indicate that the mode is active. Note that Control Mode functions are not available when the **Compare** function is active.

The Control Mode matrix is shown below, followed by descriptions of each available selection.

Simultaneously press **Up** and **Down** to return to 0.0.

0 Audio	0.0 *Input Source	0.1 SCMS	0.2 Emphasis Bk	0.3 Output Level							
1 System	1.0 Edit Mode	1.1 Mix Mode	1.2 Tempo Mode	*1.3 Bypass Mode	1.4 Pgm Bypass	1.5 Mem Protect	1.6 Auto Load	1.7 Patch Update	*1.8 KeyWord	1.9 Initialize	
2 Card	2.0 Bank Copy	2.1 Load	2.2 Format	2.3 Name	2.4 Labels						
3 MIDI	3.0 Reset	3.1 Receive	3.2 Transmit	*3.3 Pgm Change	3.4 Automation	*3.5 Send	3.6 Int. Clock	3.7 Syncs	3.8 Dump	3.9 Dump Speed	
4 Setup	4.0 Store	4.1 Load									
Map	Map 0	Map 1									
Chain	Chain Pgm Assign										
	Chain 0	Chain 1	Chain 2	Chain 3	Chain 4	Chain 5	Chain 6	Chain 7	Chain 8	Chain 9	

An asterisk (*) accompanying a parameter name indicates that there are subparameters available at that matrix location. The **Load/*** LED will light whenever an asterisk appears in the display. Press **Load/*** to step to the next subparameter. From any point in the matrix, press **Up** or **Down** together with **Load/*** to backstep to the previous parameter.

Row 0 Audio

0 Audio	0.0 *Input Source	0.1 SCMS	0.2 Emphasis Bk	0.3 Output Level
---------	-------------------	----------	-----------------	------------------

0.0 Input Source

The PCM 90 can use its own internal clock as a timing reference, or it can reference an external clock source from the rear panel S/PDIF jack. Use ADJUST to select **Dig, Analog: 48kHz** or **Analog: 44.1kHz**. When either analog rate is selected, the digital input is disabled. To process audio from the digital input, you must select **Dig**.

When **Dig** is selected, and the PCM 90 detects valid digital audio, the rate of the external word clock will be displayed with a label indicating the digital audio format type: **Prf** (Professional) or **Cns** (Consumer, also called S/PDIF).

Note: Although the PCM 90 will detect AES professional format signals, it is designed to be used with S/PDIF input. If your digital input is not S/PDIF, please be alert for locking problems and other potential errors, and be prepared to take the necessary steps to provide the correct format input signal.

<p>Audio *Input Source 0.0 Dig: Prf 44.1kHz</p>	<p>Audio *Input Source 0.0 Dig: Cns 48kHz</p>
<p>When the PCM90 is receiving valid digital audio, selecting Input Source will display the audio format and the rate of the incoming signal.</p>	

When digital clock is selected, any loss of lock detected in the incoming digital audio, or reception of non-audio data will cause the digital input to be muted. An error message will be displayed if this occurs. The PCM 90 will repeatedly try to establish lock. If a valid signal is detected, the PCM 90 will unmute and resume passing audio. The PCM 90 will always generate a valid wordclock at its digital output, even if no clock is detected at the input. The frequency of the generated wordclock will match the most recent operating sample rate.

The following types of errors are detected when the PCM 90 is set to **Dig**:

- No Lock: The PCM 90, at some point, lost lock to the incoming digital audio signal. Digital audio input is muted.
- Out of Range: The sampling rate of the incoming audio signal is outside of acceptable tolerance limits of $\pm 4\%$. Digital audio input is muted.
- Non Audio: Indicates transmission of non-audio data, such as from a CD ROM. Digital audio input is muted.
- CRC: The error is reported, but incoming audio is accepted.

Dig In Status

Pressing **Load/★** from **Input Source** will display the current digital input status. This status display is continuously updated, acting as a real-time monitor of the PCM 90 digital input. This display is active even when the PCM 90 is set to Internal clock. Note that in the case of an AES Pro format signal, "Emphasis" means either CCITT or 50/15µs emphasis.

If valid digital audio is detected, the display will show the external clock rate and format information, along with the status of the Emphasis bit(s) in the incoming audio signal. If the PCM 90 has lost lock, the display message will indicate "No Lock" and parenthetically show the internal clock rate now in use.

Upon loss of lock, or reception of non-audio data, the PCM 90 will mute the digital input and display the following messages when **Input Source** or **Dig In Status** is selected:

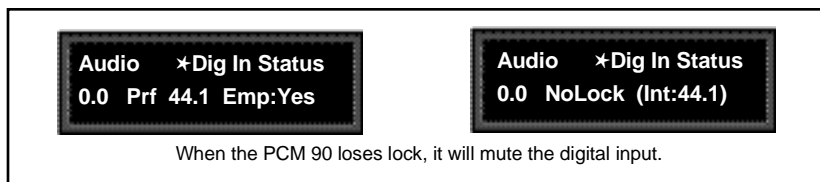

Input Source	Dig In Status
Not Locked	No Lock (Int 44.1)
Out of Range	No Lock (Int 44.1)
Non Audio: 44.1	Non Audio: 44.1

Error Log

The following errors are continuously logged and are available for review by pressing **Load/★** from the Dig In Status display and using **ADJUST** to scroll through the error list.

- Validity: A Validity error indicates that the Validity bit was set in a frame of incoming data and that the data attached to it may be corrupted. This bit may also be set when the transmitting device is paused.
- Confidence: The PCM 90 is detecting excessive jitter or noise on the digital audio line. No data has been corrupted, but corrective action should be taken.
- SlipSample: Indicates that a single sample is misaligned with the window defined by the Input Source. This may occur when an external master changes sample rate, or when it is just powering up, but should not occur in normal operation. (This type of error is reported for reference only, as the PCM 90 does not accept digital data when using its own internal clock.)

- CRC: Indicates a Cyclic Redundancy Check error in the incoming data.
 - Parity, Biphase: Indicate that at least one bit (and therefore at least one audio sample) was corrupted.
- Parity, Biphase, and Confidence errors are most often caused by inappropriate cabling. Be sure to use 75Ω video-grade cable, kept as short as possible — standard audio cable will not work reliably.

Each error is reported by name, with the number of occurrences of that particular type of error. The display might show, for example "CRC: 4752". As many as 9999 instances of each error can be shown. If the number of actual errors exceeds 9999, the display will indicate ">9999". A special symbol (■) before the error type indicates the most recently received error.

Press **Load/*** from the **Dig In Status** display and use ADJUST to scroll through the Error Log.

A typical Error Log display showing that the last error received was a CRC error (■ CRC) and that there have been more than (>) 9999 instances of CRC errors since Word Clock was last set to **Ext**.



To clear the Error Log, reselect **Dig** from the Control Mode **Input Source** display. This will cause the PCM 90 to attempt to lock to the current external source and will reset the Error Log. The log is also cleared on power up, and whenever it relocks (Auto Lock On).

0.1 SCMS

Digital audio signals, in order to comply with copyright standards, are encoded with control information which can limit the ability to copy audio data. This control information is generally known as SCMS (Serial Copy Management System). Under this system, you can choose to have the audio material processed by the PCM 90 encoded to allow one of three levels of copy restriction. To make your selection, use ADJUST to select **No Copy**, **One Copy**, or **Multi Copy**.

0.2 Emphasis Bit

The Emphasis control allows you to explicitly set the emphasis "flag" in the digital audio, or to pass along the incoming signal without changing its emphasis coding. (The PCM 90 does not perform any emphasis or de-emphasis as part of its signal processing.) The choices available with ADJUST are: **Yes**, **No**, and **Pass Thru**.

0.3 Output Level

This control allows you to select the maximum output level at the PCM 90's analog outputs. Use ADJUST to select **+4 dBu**, or **-10 dBu**.

Exercise care when switching this control, as a 14dB level change instantly occurs when going from -10dBu to +4dBu.

Row 1 System

1	1.0	1.1	1.2	1.3	1.4	1.5	1.6	1.7	1.8	1.9
System	Edit Mode	Mix Mode	Tempo Mode	*Bypass Mode	Pgm Bypass	Men Protect	Auto Load	Patch Update	*KeyWord	Initials

1.0 Edit Mode

The PCM 90 has been designed with a "plug and play" feature called **Go** mode. In this mode, the most useful parameters of each effect are grouped together in a single row which is available whenever you press **Edit**.

Each PCM 90 preset has a set of **Go** mode parameters which we've selected for you. When shipped, the PCM 90 will power up in **Go** mode, with the first preset (**P0 0.0**) loaded. Press **Edit** to display the first available parameter in the Soft Row.

If you want access to the full parameter matrix for any effect, including the Soft Row parameters, use ADJUST to select **Pro** mode. Now, when **Edit** is pressed, you can select any parameter for adjustment, and customize any effect with your own Soft Row assignments. For more information about the Soft Row, see *Editing an Effect* later in this chapter.

1.1 Mix Mode

Each PCM 90 effect has its own Mix parameter, with the Mix setting stored as an integral part of the effect. Mix Mode allows you to override these individual Mix settings and set a global Mix value for all effects. This is useful when using a mixing console's controls to set the amount of wet signal in a mix. In such a case, you can use this control to set all PCM 90 effects to 100% wet.

When shipped, the PCM 90 has the Mix Mode set to **Pgm**. This setting determines that effects will be loaded with their stored Mix settings, and allows the individual Mix controls in the edit matrix of each effect to be adjusted from 0-100% Wet. To set a global Mix value, use ADJUST to select **Global**, press **Load/*** to display the current value, and use ADJUST to assign any value from 0-100% Wet.

1.2 Tempo Mode

The PCM 90 gives you an exciting new approach to working with delay times and modulation parameters. Now you can set these parameters in *beats*, allowing you to control your effects in a completely musical way. Each PCM 90 effect has its own Tempo parameters, with tempo settings stored as an integral part of the effect. These include: Tempo Rate, Tempo Beat, Tempo Source (internal or MIDI), Tap Duration, and Tap Average. The **Global** setting here allows you to override individual Tempo Rate settings with a global value which can then be changed on the fly.

When shipped, the PCM 90 has the Tempo Mode set to **Pgm**, with each effect driven by its own stored tempo rate. To change to a global Tempo Rate, use ADJUST to select **Global**, press **Load/*** to display the current tempo in BPM (beats per minute), then use ADJUST to assign a global tempo value of 40-400BPM.

Whether Tempo Mode is set to **Global** or **Pgm**, you can set a new tempo rate by pressing the front panel **Tap** button twice. Alternatively, you can choose to have tempo set automatically from incoming MIDI clock. The rate you tap, or the MIDI tempo, will be displayed here.

For more information about working with the tempo parameters, see *Tempo Mode* later in this chapter.

1.3 Bypass Mode/Bypass Src

This control allows you to determine the behavior of the PCM 90 when the front panel **Bypass** button is pressed. You can also assign an external controller to perform identically to the front panel button. When the **Bypass** button is pressed, the LED will light, and a message indicating bypass type will be displayed. Pressing **Bypass** again will turn bypass off.

The choices available via ADJUST are:

- AllMute:** Mutes both the input and the output signal, giving complete silence.
- InputMute:** Mutes the input to the PCM 90, allowing the tail of the effect to ring out. (This is the default setting.)
- OutputMute:** Mutes the output. Audio signals are still being fed to the PCM 90, so processed audio returns immediately when **Bypass** is turned off.
- Bypass:** Completely bypasses the PCM 90, passing unprocessed audio directly through to the outputs.

To assign an external controller to perform the selected bypass function, press **Load/★** to display **Bypass Src**. Use ADJUST to select a footswitch or any MIDI controller (or Off). Once a source is selected, it will perform the same function assigned to the front panel **Bypass** button.

1.4 Pgm Bypass

This control allows you to determine the behavior of the PCM 90 when a new effect is loaded. The choices available are: **AllMute** or **Bypass**.

1.5 Mem Protect

The PCM 90 provides a memory protection feature to prevent accidental overwriting of your stored effects. When this control is set to **On**, pressing the front panel **Store** button will cause an error message to be displayed. The PCM 90 is shipped with the Memory Protection function turned **Off**.

1.6 Auto Load

This control allows you to choose whether PCM 90 effects will be loaded immediately when selected with SELECT and the **Up** and **Down** buttons (**On**), or whether they will require a press of the **Load/★** button (**Off**).

1.7 Patch Update

When a controller is patched to an effect parameter, this control determines when the controller will take control of the parameter. If **Immediate** is selected, stored parameter values will jump to the current controller position when the effect is loaded. If **Delayed** is selected, the stored parameter value will remain in effect until the controller is moved. See *Patching* later in this chapter.

1.8 KeyWord

For convenient effect sorting, the PCM 90 allows you to assign KeyWords (as many as four) to each effect. The KeyWord function here allows you to display effects according to type, or to turn this function off. Turn ADJUST to select an effect type from the list shown in the sidebar. Press **Load/★** and use ADJUST to turn the KeyWord function On or Off.

When shipped, the PCM 90 has the KeyWord function turned **On**, with **A to Z** selected. This allows you to view all of the effects in the Program or Register banks alphabetically. To access this display, press **Program Banks** or **Register Banks** repeatedly to step through all of the available banks. The KeyWord display will appear after the last bank. Press **Control** to jump to Control mode, where you can use ADJUST to select a different KeyWord for sorting. Press **Program Banks** or **Register Banks** to return to the KeyWord display — resorted according to your new selection.

Most KeyWords (except for User 1-4 which are reserved for your use) have been assigned to several presets. KeyWords are assigned to effects in Edit mode. (See *Editing an Effect*.)

1.9 Initialize

Selecting this control arms the PCM 90 to revert to its factory settings.

**This will erase all registers and setups,
and return the PCM 90 to its default states.**

If you press **Store**, the display will ask "Are you sure?" (Press STORE). If you don't want to reinitialize your unit, press any button to cancel the operation. If you press **Store** in response to this message, the display will flash "Restoring original factory settings" and your unit will be reinitialized.

PCM 90 KeyWords	
A to Z	Mastering
Acoustic	Medium
Ambience	MIDI
Ballad	Mono
Bright	Natural
Broadcast	Orchestral
Cascade	Outdoor
Chamber	Plate
Classical	RandomHall
Cncrt Hall	Room
Custom	Short
Dark	Slap FX
Dialog	Small
Drums/Perc	Spatial
Dynamic	Special FX
Echo	Splits
Film-ADR	Stereo
Gated	Surround
Guitar	Tempo
Indoor	Unnatural
Instrument	Vocal
Keyboard	User 1
Large	User 2
Live PA	User 3
Long	User 4

**Row 2
Card**

2	2.0	2.1	2.2	2.3	2.4
Card	Bank Copy	Load	Format	Name	Labels

2.0 Bank Copy

This control allows you to copy banks of effects from one location to another. Banks can be copied internally, or to and from PCMCIA Memory Cards. Try, for example, copying Preset Bank 0 into internal Register Bank R0.

1. Press **Store**. The following display will appear briefly.

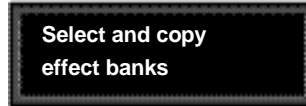

The display will then change to show:

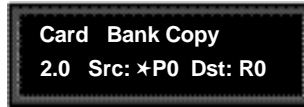

The asterisk indicates that **Src** is available for adjustment. ADJUST will scroll through all available banks, including internal preset and register banks, as well as any banks on inserted cards. Internal banks are labeled "P0...P4" and "R0, R1". Card registers will be labeled "C0, C1, C2" etc.

2. Press **Load/*** to move the asterisk to **Dst**.

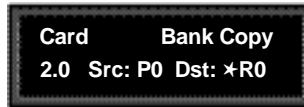

Now, use ADJUST to select the destination of your copy. **Selecting a register bank here will cause its contents to be erased and overwritten with the bank you have selected as the source when Store is pressed.**

4. Press **Store** to copy the selected source (in this case Preset Bank 0) into internal Register Bank R0. The display will ask "Are you sure?" (Press STORE). Press any button to cancel. Press **Store** to complete the store operation.

2.1 Load

This control is provided for future enhancement. It will allow you to load audio software from a Memory Card simply by inserting the new card and responding to the display prompts.

2.2 Format

This control allows you to format a Memory Card for PCM 90 use. (Make sure the Write Protect switch on the card is set to Off.) Insert an unformatted card (or one you don't mind erasing), then press **Store**. The display will ask "Are you sure?" (Press STORE). Press **Store**. The following display will appear briefly.

The display will then change as shown below.

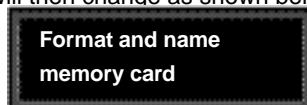

This display allows you to assign a name (of 10 characters or less) to the card.



A blinking cursor indicates that a particular character is available for changing. Use ADJUST to select the character you want in that position. Turn SELECT to move the cursor to another character. Press **Store** to execute. The display will ask "Are you sure?" (Press STORE). Press **Store** again to complete the operation. Press any front panel button to cancel.

2.3 Name

This control allows you to rename a formatted card. Insert a formatted card and press **Store**. The card name will be displayed with the blinking cursor as shown above. Use ADJUST to select a new character at the location marked by the cursor. Turn SELECT to move the cursor to another position. Press **Store** twice to execute.

2.4 Labels

This control allows you to rename Register bank and row labels. Any changes made here are executed immediately. To rename bank and row labels, press **Store** and use ADJUST to display any bank. Press **Load/★** to access the naming function for the selected bank, then use ADJUST and SELECT to enter a new bank name.

Press **Load/★** to display the first row in the selected bank. Use ADJUST to select any other row within the bank. Press **Load/★** to access the naming function for any displayed row, then use ADJUST and SELECT to enter a new bank name.

Pressing **Load/★** from the row label naming display will jump you back to bank selection.

PCM 90 Character Set
! " # \$ % & ' () * + , - . / 0 1 2 3 4 5
6 7 8 9 : ; < = > ? @ A B C D E F G
H I J K L M N O P Q R S T U V W
X Y Z [\] ^ _ ` a b c d e f g h i j k l
m n o p q r s t u v w x y z { } ~ ■
(space)
The @ and the \$ symbols are used to represent Custom Control values.

**Row 3
MIDI**

3 MIDI	3.0 Reset	3.1 Receive	3.2 Transmit	3.3 Pgm Change	3.4 Automation	3.5 *Send	3.6 Int Clock	3.7 SynEx	3.8 Dump	3.9 Dump Speed
-------------------	--------------	----------------	-----------------	-------------------	-------------------	--------------	------------------	--------------	-------------	-------------------

3.0 Reset

This control resets all patched parameters to their previously stored values. When this control is activated, a MIDI "Reset All Controllers" message is also transmitted on the current channel by the PCM 90.

3.1 Receive

Turn ADJUST to select **OFF**, **1-16**, or **OMNI** for receipt of MIDI messages.

3.2 Transmit

Turn ADJUST to select **OFF**, or **1-16** for transmission of MIDI messages.

3.3 Pgm Change

This control specifies the PCM 90's response to incoming MIDI Program Change messages. There are four selections available via ADJUST: **On**, **Off**, **Map** and **Chain**.

Pgm+ and **Pgm -**, are available as subparameters in each location. **Pgm+** will load the next higher effect in the current bank, map, or chain. **Pgm -** will load the next lower effect. You can select the following sources to activate **Pgm+** and **Pgm -**:

- Off
- Footswitch 1
- Footswitch 2
-
-
-
- MIDI Controller #119

On

Program Change messages 0-49 correspond to PCM 90 Effects 0.0-4.9 in the current bank. Program Change messages 50—127 are ignored. The current bank can be changed with MIDI Continuous Controller 32 and Bank Select Messages as follows:

- 0-4: Program Banks 0-4
- 5-6: Internal Register Banks 0-1
- 7-11: reserved for ROM Card Banks
- 12-20: Memory Card Banks. The number of banks available on a given card will vary with its size, as follows:

Card Size	# Banks
64	1
256	5
512	10
1 Meg	20

Off

All Program Change and Bank select messages are ignored.

Map

Program Change 0-127 can be mapped to any PCM 90 effect in any internal or card bank. Two 128 element maps are stored internally, additional maps may be stored on RAM cards. Once you have selected **Map**, press **Load/★** to display:

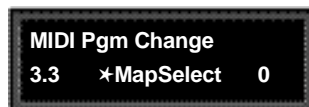

Turn ADJUST to select the desired Program Change Map.

Chain

Any Program Change number can be selected to load any one of ten customized effect "chains". Additional chains can be stored on RAM cards. Once a chain is loaded, effects in the chain are accessed by the controller patched to **Pgm +** and **Pgm -** (program increment and program decrement). Once you have selected **Chain**, press **Load/★** to display:



Turn ADJUST to select the desired Program Chain. When set to **MIDI**, Program Chains will be loaded by MIDI Program Change messages according to the settings of Chain Pgm Assign in Row 6.

To load a specific Program Chain, without sending the PCM 90 a MIDI Program Change message, use ADJUST to display the desired chain number.

**3.4 Automation**

This control is provided to allow one PCM 90 to act as a master for any number of slaved PCM 90s. Select **On** to have values resulting from front panel operations sent out as SysEx messages. Press **Load/★** to select the ID (**0-126** or **All**) of the target PCM 90(s).

3.5 Send (Foot Pedal, Foot Sw 1, Foot Sw 2, ADJUST, Custom 1-4)

If **Transmit** is set to **On** these controls can transmit MIDI controller messages. Press **Load/★** to cycle through the controller selections. Use ADJUST to select the MIDI Controller message to transmit. Receipt of MIDI Controller messages will affect the PCM 90 in the same manner as if the internal controls were adjusted.

3.6 Int Clock

You can choose to have the PCM 90 transmit MIDI Clock at the current tempo rate by setting this control to **On** and Tempo mode **Source** (0.2) to **Internal**. If this control is set to **Off**, MIDI Clock will not be transmitted.

3.7 SysEx

This control is provided for communication with one or more additional PCM 90s or computer editor software. **On** (the default setting) allows SysEx messages to be received by the PCM 90. Press **Load/★** to select device ID (**0-126**).

3.8 Dump

Press **Store** to configure the PCM 90 to execute MIDI dumps of single effects, banks, maps, chains, or setups.

3.9 Dump Speed

Turn ADJUST to select dump speeds of **Slow**, **Medium** or **Fast** to achieve compatibility with the connected MIDI device.

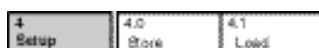

Row 4 Setup

4.0 Store

Control mode Audio, System, and MIDI parameter settings, along with two settings from the Tempo matrix, comprise a "Setup." Five setups can be stored and named in the unit, or on a Memory Card, allowing you to transport not only your effects, but complete PCM 90 environments to another PCM 90. Press **Store** to initiate the Setup Store function.

When the PCM 90 is shipped (or when you reinitialize the unit) default values are assigned to these parameters. The following table shows the Setup parameters along with the factory default setting of each parameter.

Control Mode			
Matrix Location		System Parameter	Default Setting
Audio	0.0	Input Source	Analog: 48kHz
	0.1	SCMS	Multi Copy
	0.2	Emphasis Bit	Pass Thru
	0.3	Output Level	+4dBu
System	1.0	Edit Mode	Go
	1.1	Mix Mode	Pgm
		Global Mix Value	100% Wet
	1.2	Tempo Mode	Pgm
		Global Tempo Value	120 BPM
	1.3	Bypass Mode	InputMute
		Bypass Src	Off
	1.4	Pgm Bypass	AllMute
	1.5	Mem Protect	Off
1.6	Auto Load	Off	
1.7	Patch Update	Delayed	
1.8	KeyWord	On (A to Z)	
MIDI	3.1	Receive	OMNI
	3.2	Transmit	1
	3.3	Pgm Change	On
		Pgm+	Off
		Pgm-	Off
		Map select	0
		Chain	MIDI
	3.4	Automation	Off
	3.5	Footpedal	None
		Sw 1	None
		Sw 2	None
		ADJUST	None
		Custom 1-4	None
3.6	Int Clock	Transmit Off	
3.7	SysEx	Receive On	
	Device ID	0	
3.8	MIDI Dump	Current Program	
3.9	Dump Speed	Slow	
Tempo Mode			
Matrix Location		System Parameter	Default Setting
Tempo	0.2	Source	Internal
	Tap	1.3	Display

4.1 Load

This control allows you to load any of five stored setups, restore the factory default setup shown above, or load a setup from a Memory Card. Press **Load/★** to cycle through the selections. (Memory Card selections will only appear when an appropriate card is inserted.)

**Row 5
Mapx**



Map 0 and Map 1

When Control mode 3.3 is set to **Map**, received MIDI Program Change messages will be mapped according to the selections made here. The selections available are: **MIDI Program Change #** (0-127), **Bank #** (PCM 90 preset, register, or card bank) and **Pgm #** (PCM 90 effect number 0-49). When shipped, the PCM 90 has the two internal maps configured to access all presets and registers:

Map 0	Map 1
MIDI 0 = P0 0.0	MIDI 0 = P2 2.8
MIDI 127 = P2 2.7	MIDI 121 = P4 4.9

**Row 6
Chain**

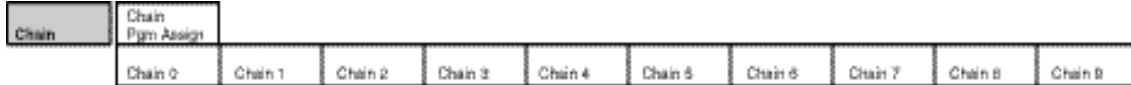

The PCM 90 has 10 internal program chains, numbered 0-9. (Ten additional chains are available if a memory card is inserted.) Each chain is made up of 10 "links" (numbered 0-9). You can assign any program or register to any link in the chain.

A chain can be loaded with a MIDI Program Change message, or by selecting its number directly at Control mode 3.3. Once a chain is loaded, the source assigned to **Pgm+** and **Pgm-** will load the next higher or lower program in the chain.

Pgm Assign

When Control mode 3.3 is set to **Chain**, received MIDI Program Change messages will be mapped according to the selections made here. Two assignments are available: **MIDI Program Change #** (0-127) and **Chain #** (0-9). When the PCM90 is shipped, all program numbers are mapped to Chain #0. To change assignments, set **Pgm#**, with ADJUST, press **Load/★** to move the **★** to **Chain#** and set it with ADJUST. (You cannot assign more than one chain/MIDI #.)



Chain 0-9

Use SELECT to choose a chain. Once a chain is selected, any PCM 90 program or register can be assigned to any link in the chain. Press **Load/★** to move the **★** from **Link#** to the Bank ID, to the program number. Depending on the field marked with the **★**, ADJUST will select link numbers 0-9, Banks (Pn or Rn), or the desired program within the displayed bank.

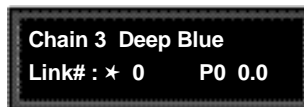

The PCM 90 has 250 factory-designed programs, organized into five Program Banks of 50 each, and 100 memory locations, called registers, for storing your customized effects. Two Register Banks are available in the PCM 90 itself. Additional Register Banks can be stored on PCMCIA cards.

Program and Register Banks

The PCM 90 has 5 Program Banks, each with 50 factory-designed programs

Two Register Banks provide 100 memory locations for storing your own effects.

All PCM 90 programs have one or more parameters patched to the ADJUST knob. In Program Banks or Register Banks mode, turn ADJUST to change the sound of the currently running effect. While ADJUST is turned, the patch name and value are displayed. Custom Controls allow you to create additional group parameter controls.

The procedure for loading effects is the same, whether you are choosing from banks of factory presets, or from your own banks of registers. When first turned on, the PCM 90 will load whatever effect was running when it was last turned off. When shipped from the factory, the first effect in the first Program Bank (**P0 0.0 Deep Blue**) is loaded. The Bank ID (**P0, P1, P2, P3, P4**), matrix location, program name, and bank and row labels are all displayed.

Selecting Effects

Turn SELECT to display another effect.

An asterisk in the display indicates that the displayed effect is not loaded.

Press **Program Banks** repeatedly to cycle through the program banks. Simultaneously press **Program Banks** along with either **Up** or **Down** to backstep.

SELECT will scroll sequentially through all of the effects in one bank and then begin scrolling through the next bank. Press **Program Banks** to reselect the last displayed effect in another bank. Press **Load/★** to load any displayed effect.

In the Program and Register Banks, ADJUST is a Soft Knob. Each of the factory-designed programs has one or more parameters patched to this knob, providing a quick way to make useful changes to the effect.

Turning ADJUST will display the patch name and the current value, as well as any name assigned to the current value. Continue turning ADJUST to alter the patched parameter's value. You can create your own ADJUST knob parameter assignments for your registers. (See *Editing*, later in this chapter.)

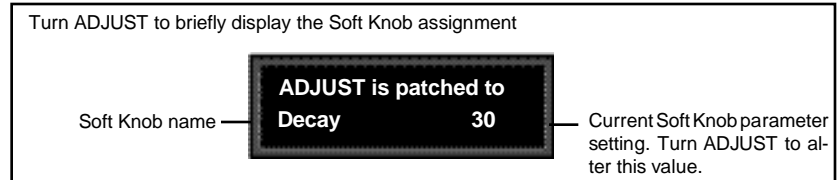

Note that scrolling through the effects in the Program or Register banks will not load the effects, but will merely display them (unless you have specifically turned on the Auto Load function in Control Mode). Displayed effect names will be preceded by an ✱ indicating that they can be loaded by pressing **Load/✱**. (The **Load / ✱** LED will light to indicate that the load function is available.) To find out at any time what the currently running effect is, press and hold **Program Banks** or **Register Banks**. An Info message will be displayed providing the name of the currently running effect, as well as the algorithm from which it is derived.

To select an effect stored in a register, press **Register Banks**. If you have registers stored on a memory card, and have the card inserted, pressing **Register Banks** repeatedly will cycle through all of your stored bank selections. Simultaneously press **Register Banks** along with either **Up** or **Down** to backstep. Turn **SELECT** to scroll through all of the effects in the bank. As in Program Banks mode, an asterisk in front of the effect name indicates that the displayed effect is not loaded. Press **Register Banks** to reselect the last displayed effect in another bank. Unused registers are indicated by the message "available" on the display. Press **Load/✱** to load the displayed effect.

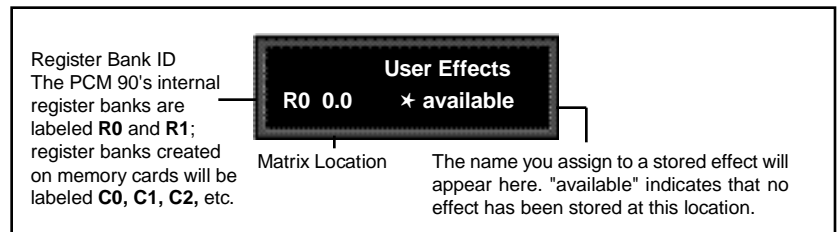

The organization of programs in the five program banks and descriptions of the 250 preset programs are given in Chapter 3.

Each bank and row in the Program and Register Banks has a descriptive name to help you locate different types of effects. For instance, if you want to process dialog to sound as though it's in a shower stall, the **Rooms** bank is a good place to start. Bank and row labels appear on the top line of the display in Program and Register modes.

Banks and rows that you create yourself can be renamed at **Control 2.4**.

To make finding the effects you want even easier, the PCM 90 has an effect sorting function called *KeyWord* which lets you display only a selected type of effect. When the *KeyWord* function is activated (at **Control 1.8**), pressing **Program Banks** or **Register Banks** one push beyond the available banks will access a list of effects sorted by one of the *KeyWords* shown in the sidebar. **SELECT** will scroll you through the effects in that category. When shipped, the PCM 90 has the *KeyWord* function turned on, with **A to Z** selected. This displays all of the effects in alphabetical order. Each preset has at least one *KeyWord* assignment.

The *KeyWord* categories cover a wide variety of effect types. To select a different *KeyWord* for sorting, go to **Control 1.8**. (If you are in the *KeyWord* section of the Program Banks or Register Banks mode, pressing **Control** will jump you directly to this location.) Turn **ADJUST** to select any *KeyWord* from the list. Now, when you return to Program Banks or Register Banks mode, the display of programs will be limited to those which have been tagged with that particular *KeyWord*.

KeyWords are assigned to effects in Edit mode. As many as four *KeyWords* can be assigned to a single effect to allow sorting into more than one group. An effect might, for example, be assigned the *KeyWords*: Acoustic, Ballad, Guitar and Small. The effect would then be displayed when any of these *KeyWords* was selected.

To turn the *KeyWord* function off, go to **Control 1.8 System *KeyWord**. Press **Load/★** and use **ADJUST** to select On or Off.

Bank and Row Labels

Sorting Effects

PCM 90 KeyWords	
A to Z	Mastering
Acoustic	Medium
Ambience	MIDI
Ballad	Mono
Bright	Natural
Broadcast	Orchestral
Cascade	Outdoor
Chamber	Plate
Classical	RandomHall
Cncrt Hall	Room
Custom	Short
Dark	Slap FX
Dialog	Small
Drums/Perc	Spatial
Dynamic	Special FX
Echo	Splits
Film-ADR	Stereo
Gated	Surround
Guitar	Tempo
Indoor	Unnatural
Instrument	Vocal
Keyboard	User 1
Large	User 2
Live PA	User 3
Long	User 4

Tempo Mode The PCM 90 gives you unique control over tempo. In the PCM 90, tempo is not just a matter of setting echo rates. Any delay parameter and any time-based modulator (LFO1, LFO2, Sw 1, Sw 2 and Mod: Delay) can be individually assigned to an absolute time value, or assigned to a tempo value.

For example, a delay time can be set to a specific number of milliseconds, and you will always get a delay of that number of milliseconds, regardless of tempo changes. Alternatively, a delay time can be set to a specific ratio of echoes to beats. Now, if you create a rhythmic echo pattern, delay times will be linked to tempo. When you change tempo, the delay time will change to maintain the same rhythm at the new tempo.

With the LFOs, time-based switches, and Mod: Delay, the rate of change can be an absolute value (such as once per second), or it can be linked to tempo (for example, once every four beats). Almost any delay parameter, or time-based modulator, can be set to its own individual rhythm, allowing you to set up an effect which will change in a rhythmically interesting way — evolving over time, for example, as opposed to being a mere series of repetitions. Once delays and time-based modulators are assigned, tempo rate can be easily changed in a variety of useful ways.

Tempo **Rate** can be set internally or via MIDI. If Tempo **Source** is set to **Internal**, you can dial in any tempo from 40-400 BPM at location 0.0 in the Tempo mode matrix. Alternatively, you can press the front panel **Tap** button twice in rhythm to establish the rate you want, or you can have the value of a patch source act as a tap trigger. (See *Patching*.) The tap function, whether performed by the front panel **Tap** button, or by an assigned controller, is always active, allowing you to change tempo on the fly from any mode. You can also choose to have your tempo transmitted as a MIDI Clock signal to control the tempo of connected MIDI devices (Control mode 3.6). If **Source** is set to MIDI Clock, PCM 90 tempo will sync to incoming MIDI Clock. Whether tempo is set internally or via MIDI, the LED in the Tempo button will flash at the current rate. (You can disable the Tempo LED flashing under Tempo mode 1.3.) Press and hold the **Tempo** button at any time to display the current Tempo **Rate** and **Source**.

Each effect in the PCM 90 has its own tempo rate setting which is stored with the effect. You can override these individual tempo rates with a global tempo rate at Control Mode 1.2. Tempo is also available as an independent patch source which can control any effect parameter. (See *Patching* later in this chapter.)

When **Compare** is on, **Tap** will not alter the tempo, but will still reset the LFOs. See Chapter 3 *Modulation*.

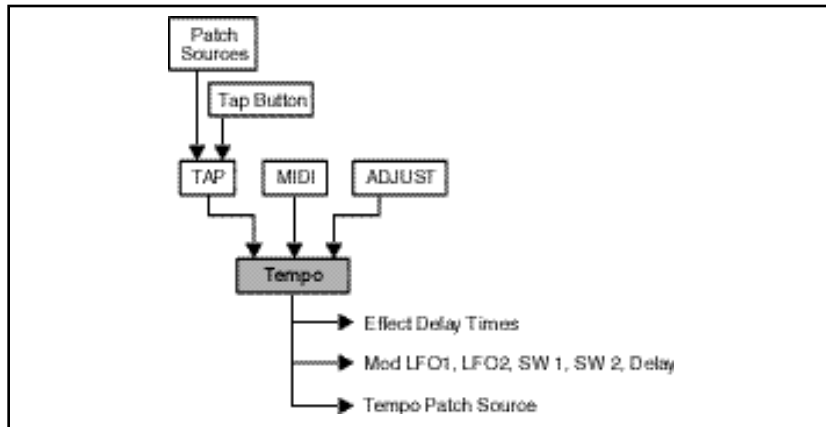

Press **Tempo** to access the following tempo parameters:

The Tempo Mode Matrix

Simultaneously press **Up** and **Down** to return to 0.0.

0	0.0	0.1	0.2	
Tempo	Rate	Beat Value	Source	
1	1.0	1.1	1.2	1.3
Tap	Duration	*Source	Average	Display

An asterisk (*) accompanying a parameter name indicates that there are subparameters available at that matrix location. The **Load /*** LED will light whenever an asterisk appears in the display. Press **Load /*** to step to the next subparameter.

From any point in the matrix, press **Up** or **Down** together with **Load /*** to backstep to the previous parameter.

0	0.0	0.1	0.2
Tempo	Rate	Beat Value	Source

Row 0 Tempo

0.0 Rate

This is the current tempo (in Beats Per Minute). When 0.2 is set to **Internal**, turning ADJUST allows you to select a different rate (40-400 BPM). The Tempo LED will flash at the new rate. Note that fractional tempos can be tapped in, but are not available via ADJUST. The display will always show the nearest whole number value.

0.1 BeatValue

Tempo is expressed in BPM. This control allows you to specify the value of the beat. Eighth, dotted-eighth, quarter, dotted-quarter, half, dotted-half, and whole-note values are available. If, for example, the rate is 120 BPM, and you select eighth-note here, the tempo will be 120 eighth-notes per minute. If you select quarter-note here, the tempo will be 120 quarter-notes per minute. (The factory default is quarter-note.)

0.2 Source

You can choose to have tempo determined by the PCM 90 **Tap** and **Rate** controls (Internal), or by MIDI Clock. When MIDI Clock is selected as the tempo source, **Tap** acts as a reset, setting the downbeat of the LFO and the time-based switches.

**Row 1
Tap**

1	1.0	1.1	1.2	1.3
Tap	Duration	Source	Average	Display

1.0 Tap Duration

This control determines how many beats will occur in a tap interval. The default setting (1 beat) is probably adequate for most applications. With the default setting of 1 beat, if the tempo is set to 120 bpm, and the beat value is set to quarter-note, each TAP = 1 quarter-note = 1 beat. Available values are: 1/8, 1/7, 1/6, 1/5, 1/4, 1/3, 1/2, 1-8 beats

1.1 Tap Source and Tap Level

Press **Load**/* to toggle between these two controls.

Tap Source allows you to assign the Tap function to any of the PCM 90's Internal, MIDI, or MIDI controllers as listed under Patching.

Tap Level allows you to set the level at which the Tap function is triggered.

1.2 Average

This control allows you to average the last 2-8 taps. Higher numbers mean that the response to incoming taps will be more gradual. (The tempo is updated on every tap, but with a value which is the average of the last 2-8 taps.) Higher average values are more useful if you're trying to lock into a pre-recorded track.

1.3 Display

This control allows you to disable the flashing of the Tempo LED. Turn ADJUST to select **Off**. The Tempo LED will turn off.

With 5 algorithms and 250 preset effects, the PCM 90 gives you a lot to play with right out of the box. An enormous range of editing control is provided for each algorithm, with parameters organized into a simple edit matrix. In addition to providing this powerful sound design capability, the PCM 90 is also designed to allow you to customize these controls for your day-to-day editing needs, or to simply use a subset of controls specially designed for each preset.

This section will describe three basic levels of editing, from the simplest "plug and play" method, through the full edit matrix.

Every preset in the PCM 90 has one or more of its available parameters patched to the front panel ADJUST knob. This Soft Knob provides the first level of editing control. Once you have loaded a preset, simply turn ADJUST to alter the effect.

When shipped, the PCM 90 will power up with the first preset (**P0 0.0 Deep Blue**) loaded. The following display will appear:

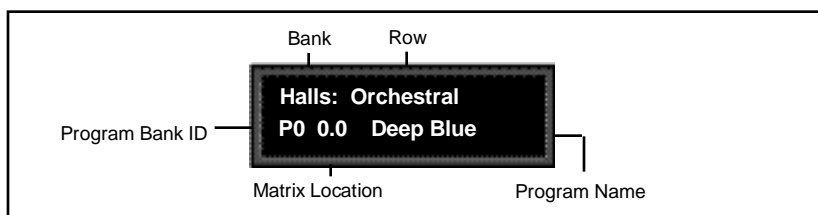

Turn ADJUST. The display will change to show the name assigned to the ADJUST patch, and the current value of the patch. Continue turning ADJUST to change the value of the patch along its entire range. The range of ADJUST knob control can be limited in the Custom row of the edit matrix, making it possible, for example, to have a range of only 0...1, in order to have the ADJUST knob behave as an Off/On control. Many of the presets have range limits to make them more convenient to use, and some have text assigned to range values for even greater clarity. In some of the presets, the changes effected by ADJUST will be as simple as altering the wet/dry mix. In others, turning ADJUST will affect multiple parameters over the complete control range of 0-127.

Details on how to create your own ADJUST knob patches are given at the end of this chapter under *Patching*.

Editing an Effect

The Soft Knob

Controlling the Soft Knob with a Foot Pedal

If you have a foot pedal connected to the PCM 90 rear panel Foot Controller jack, you can use it to control the soft knob patch. (Note that no MIDI connections are required to do this.)

To assign a foot pedal control over the soft knob patches, set both Control mode 3.5 **ADJUST** and Control mode 3.5 **Foot Pedal** to the same MIDI Controller. See Chapter 5 *MIDI Operation*.

Beyond simple ADJUST knob editing, the PCM 90 offers two levels of editing control, called **Go** mode and **Pro** mode. **Go** mode is designed to be a basic "plug and play" mode, with easy access to a specific set of preset parameters. For each of the 250 presets, we have designed a Soft Row containing those parameters which allow you to make value changes to the effect *without* losing the character of the sound.

The Soft Row When shipped, the PCM 90 will power up in **Go** mode with the first preset (**P0 0.0 Deep Blue**) loaded. Press **Edit** to display the Soft Row of parameters which have been designed for this preset. In this example, 10 soft row parameters have been assigned. The name of each Soft Row parameter is displayed, along with a reference to its row in the Edit matrix.

Turn **SELECT** to scroll all of the available parameters in the Soft Row. Turn **ADJUST** to change the value of any displayed parameter along its entire range.

Each preset has a Soft Row of parameters which have been specifically selected to provide everything you need to play with the effect. This example shows the Soft Row for **P0 0.0 Deep Blue**.

An asterisk in front of a displayed parameter indicates additional parameters are available when you press **Load/***.

Control	Custom	Controls	Time	Time	Time	Time	Design	Reverb	Delay
Mix	Blended/Widh	In/Lvl	Low Ft.	Crossover	Rt HC	Pra Delay	Size	Mstr Dy	Mstr Dy
0	Gain	Eq	0.1	0.2	0.3	0.4	0.5	0.6	0.7
1	Time	0.1	0.2	0.3	0.4	0.5	0.6	0.7	0.8
2	Design	0.1	0.2	0.3	0.4	0.5	0.6	0.7	0.8
3	Reverb	0.1	0.2	0.3	0.4	0.5	0.6	0.7	0.8
4	Delay	0.1	0.2	0.3	0.4	0.5	0.6	0.7	0.8
5	Reverb	0.1	0.2	0.3	0.4	0.5	0.6	0.7	0.8
6	Reverb	0.1	0.2	0.3	0.4	0.5	0.6	0.7	0.8
7	Reverb	0.1	0.2	0.3	0.4	0.5	0.6	0.7	0.8
8	Reverb	0.1	0.2	0.3	0.4	0.5	0.6	0.7	0.8
9	Reverb	0.1	0.2	0.3	0.4	0.5	0.6	0.7	0.8



Turn **SELECT** to move horizontally across the Soft Row.

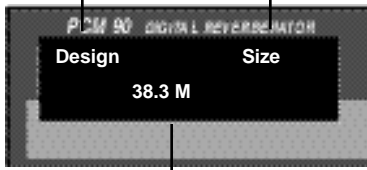

Use **ADJUST** to change the value of a displayed parameter.

The Soft Row display shows:
 an Edit matrix row label...
 ... the name of the parameter...

 ... and the current parameter value.

Each effect has four available Custom Controls which can be patched to one or more parameters and assigned to the Soft Row. Like the ADJUST knob, Custom Controls can be individually named and can have customized range limits to make them more useful. In the presets, Custom Controls are assigned to the Soft Row in sequence after Mix, so that their positions in the Soft Row will always relate to their Control number. This is a convention you may want to follow in creating your own Soft Rows.

Whenever you edit a PCM 90 effect from the front panel, the LED in the **Compare** button will light. This lets you know that the effect has been altered since the last store operation, and that the edit compare function is active. Whenever this light is on, you can press **Compare** to hear the original version of the effect. A message will be displayed to inform you that the stored version of the effect is being loaded. Although this message is only displayed briefly, the **Compare** LED will flash to let you know the effect you are hearing is the stored version. While **Compare** is on, you can use the SELECT knob and the **Up** and **Down** buttons to view parameter values in the stored effect.

Compare

Press **Compare** again to reload your edited version. Another message will be displayed, and the **Compare** LED will stop flashing and remain lit until you store your edited version, or select and load another effect.

Note: Altering parameter values with patched sources other than ADJUST or Custom Controls will *not* light the LED.

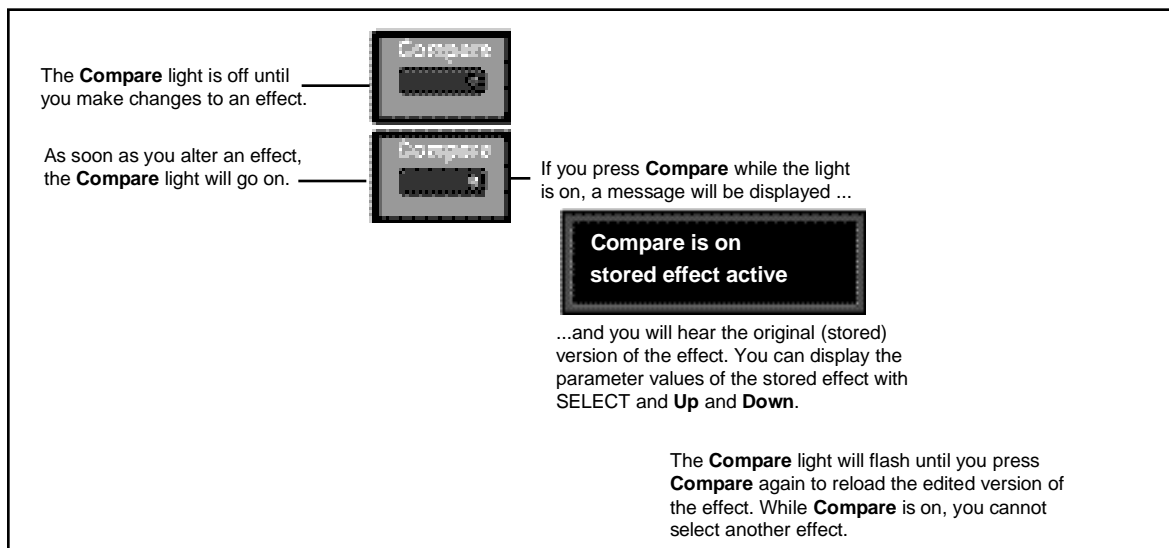

The front panel **Bypass** button is always active, and will turn on the type of bypass (**AllMute**, **InputMute**, **OutputMute**, or **Bypass**) selected in Control Mode 1.3.

Bypass

When you press **Bypass**, the button LED will light and a message will be displayed to inform you that bypass is on. The display message will also indicate the type of bypass which is in effect. Press **Bypass** again to turn both the LED and the bypass condition off. A brief display message will inform you that bypass is off.

Press and hold **Bypass** to display the current state and type of bypass.

Store Operations **Turning Memory Protection On**

The PCM 90 is shipped with its Memory Protection option off. To turn Memory Protection on, press **Control** and use **Up** and **Down** and **SELECT** to display matrix location 1.5. The display should read:



Turn **ADJUST** to select **On**. With Mem Protect on, when you press the front panel **Store** button, the following message will be displayed:



The PCM 90 will then jump to the Mem Protect display (**Control 1.5**) where you can use **ADJUST** to turn Mem Protect off.

Storing an Effect

With Memory Protection disabled, pressing **Store** will cause a message like the following one to be displayed:

An asterisk (*) is positioned in front of the display label which is available for changing — in this case, the name of the effect.

The default Bank and register location will appear here.

"available" means that this location is empty. If an effect is stored at this location, its name will appear here.

Press **Load/*** to move the cursor from the name, to the register bank, and again to select the register location within the selected bank.

How the PCM 90 selects a default Bank and Register

If a register is loaded when **Store** is pressed, the default location will be the same as the loaded effect. If a preset is loaded when **Store** is pressed, the default location is determined as follows:

The PCM 90 always uses the last-stored register location as a starting point. Its default choice is the next "available" register within that bank. If there are no available registers at a higher location number within the same bank, the default location will be that of the last stored register.

If the last stored register is on a RAM card, and the RAM card is not inserted, the PCM 90 will search for available registers starting at 0.0 in the Internal Register Bank R0.

If you press **Store** again, the display will ask "Are you sure?" (Press **STORE**). Pressing **Store** will cause the currently running effect to be saved, as is, in the location shown in the lower lefthand corner of the display. A brief message will inform you that the effect is being stored, then the PCM 90 will revert to the mode it was in before **Store** was pressed, with the newly-stored effect loaded.

- When you store an effect, the following things are saved:
- Values of all Edit matrix parameters. This includes the initial values for any patch destinations when **Patch Update** (Control mode 1.7) is set to **Delayed**.
 - Soft Row parameter assignments.
 - Value of **ADJUST** when the effect was stored.
 - Last parameter selected when the effect was stored.
 - Tempo **Rate** and **BeatValue**.
 - Tap **Duration** and **Average**.
 - All names, labels and values for **ADJUST** and Custom Controls.
 - Effect name.

Renaming the Effect

Renaming an effect is straightforward. With the asterisk and the cursor positioned as shown, turn ADJUST to select a new character. Press **Up** or **Down** to select a new *type* of character (upper case, lower case, numeric, symbolic, or blank). Simultaneously press **Up** and **Down** to clear all characters from the cursor to the end of the line. Turn SELECT to reposition the cursor over another character, and use ADJUST to change it. Continue in this manner until you have finished entering the new name. A maximum of 12 characters (including spaces) may be used.

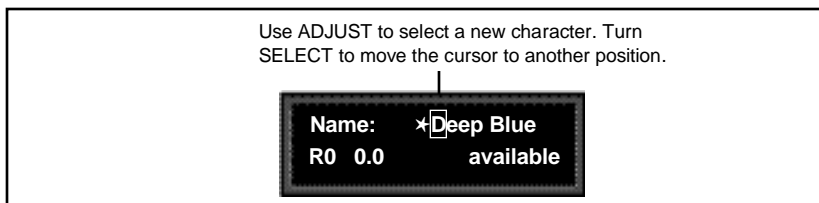

PCM 90 Character Set
 ! " # \$ % & ' () * + , - . / 0 1 2 3 4 5
 6 7 8 9 : ; < = > ? @ A B C D E F G
 H I J K L M N O P Q R S T U V W
 X Y Z [\] ^ _ ` a b c d e f g h i j k l
 m n o p q r s t u v w x y z { : } ~ ■
 (space)

The @ and the \$ symbols are used to represent Custom Control values.

Selecting a Bank and Register Location

Press **Load/*** to move the asterisk to the Register Bank ID.

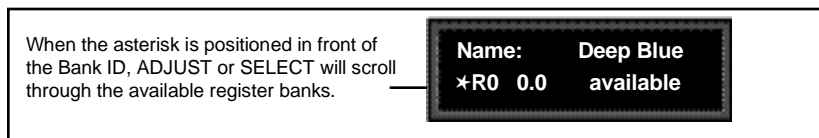

Press **Load/*** again to move the asterisk to the register matrix location.

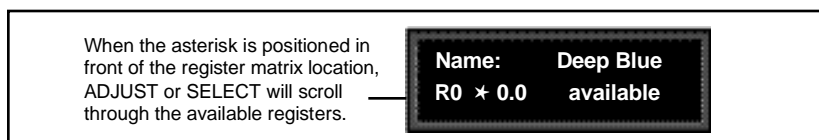

Once you have made all the changes you want to an effect, and have selected a register location, press **Store**. If you press **Store**, the display will ask "Are you sure?" (Press STORE). If you don't want to save the effect as shown, press any button to cancel the operation. Press **Store** to complete the operation.

The Full Edit Matrix Setting Edit Mode to **Pro** (Control Mode 1.0) gives you access to the full parameter matrix of the algorithm for any loaded effect whenever you press the front panel **Edit** button.

To select any parameter for adjustment, use **SELECT** to move horizontally across the matrix and the **Up** and **Down** buttons to move vertically. An asterisk (*) appearing before a displayed parameter indicates that more than one parameter is available at that location. Press **Load/*** to display these additional parameters.

Each of the five PCM 90 algorithms has a unique matrix, but many parameters are common to all effects, and their placement within the matrix is consistent. For example, all parameters within a given row of any matrix are related. This type of grouping is immediately apparent from the name of the row. For example the "Time" row in any matrix will contain all of the available duration controls for the effect's reverberator.

As far as possible, rows with similar controls will always appear in the same position in the matrix and, within each row, parameters will generally appear in the same position. For example, the first row (0) in every algorithm is "Controls". The **Mix** parameter, which is available in all effects, is always located in position 0 in this row. Similarly, the last three rows of every matrix are "Modulation," "Patches" and "Custom". This makes it very easy to find your way around the large number of available parameters, and to anticipate where to find the controls you are looking for when you switch between effects.

Concert Hall						
0 Controls	0.0 Mix	0.1 In Lvl	0.2 InWidth	0.3 RvbOutLvl	0.4 OutWidth	
1 Time	1.0 Lvs Rt	1.1 Mid Rt	1.2 Crossover	1.3 R.HC	1.4 Pre Delay	
2 Design	2.0 Size					
3 Reflect	3.0 *Matr Div					
4 Compress	4.0 Ratio					
5 Expand	5.0 Ratio					
6 Spatial EQ	6.0 Premix					
7 Modulation	7.0 *Mod LFO					
Patches	Patch 0					
Custom	*ADJUST					

Rich Plate						
0 Controls	0.0 Mix	0.1 In Lvl	0.2 InWidth	0.3 RvbOutLvl	0.4 OutWidth	
1 Time	1.0 Lvs Rt	1.1 Mid Rt	1.2 Crossover	1.3 R.HC	1.4 Pre Delay	
2 Design	2.0 Size					
3 Reflect	3.0 *Matr Div					
4 Echo	4.0 *Mat					
5 Delay	5.0 *Mat					
6 Modulation	6.0 *Mod					
Patches	Patch 0	Patch 1	Patch 2	Patch 3	Patch 4	Patch 5
Custom	*ADJUST	*Control 1	*Control 2	*Control 3	*Control 4	

Ambience									
0 Controls	0.0 Mix	0.1 In Lvl	0.2 InWidth	0.3 RvbOutLvl	0.4 OutWidth				
1 Time	1.0 Decay	1.1 Decay Lvl	1.2 Pre Delay	1.3 Dry/Dly	1.4 Dry/Dly Mix				
2 Design	2.0 Size	2.1 Diffusion	2.2 Spin	2.3 Wander	2.4 High Cut				
3 Modulation	3.0 *Mod LFO1	3.1 *Mod LFO2	3.2 *Mod AR Env	3.3 *Mod Follow	3.4 *Mod Latch	3.5 *Mod SW 1	3.6 *Mod SW 2	3.7 *Mod Delay	3.8 *Mod SS Hold
Patches	Patch 0	Patch 1	Patch 2	Patch 3	Patch 4	Patch 5	Patch 6	Patch 7	Patch 8
Custom	*ADJUST	*Control 1	*Control 2	*Control 3	*Control 4	KeyWord 1	KeyWord 2	KeyWord 3	KeyWord 4

Similar parameters can be found in similar positions in every effect matrix. Once you are familiar with one edit matrix, you will find it easy to anticipate where to find controls in another matrix.

Detailed information about each individual edit matrix, as well as parameter and effect descriptions are given in Chapter 3.

Creating a Soft Row

In **Pro** mode you still have complete access to the Soft Row, which appears above row 0 of the full edit matrix. The parameters assigned here are duplicates of selected parameters in the matrix and can be adjusted from Row **S** (Soft Row), or from their matrix location.

The following example shows the edit matrix for the preset, **P 0.0 Deep Blue** (Random Hall algorithm). As you can see, parameters from locations throughout the matrix have been assigned to this Soft Row. In this preset (and in every preset) we have designed the Soft Row by assigning the Mix control first, followed by any Custom Controls, then the parameters in numerical order. Parameters from the Controls row are assigned in order to the first locations, followed by assignments from the Time row, and so on. As Soft Row parameters are also labeled with the name of the row from which they were taken, this makes it relatively easy to find the source parameter for any Soft Row assignment.

In the presets, the convention of assigning Custom Controls 1-4 to Soft Row positions 1-4 allows you to identify the original control by its corresponding number, even when a name has been assigned to it.

The Soft Row assigned to an effect appears above Row 0 in the full Edit matrix.

0 Soft Row	Default Mix	Control StereoWidth	Control PreDelay	Time Low F	Time Onset at	Time Off H/C	Time Pre Delay	Length Time	Default MIDI Ch	Default MIDI Dy
1 Mix	S.0	S.5	S.2	S.1	S.3	S.4	S.6	S.7	S.8	S.9
2 PreDelay	T.0	T.1	T.2	T.3	T.4	T.5	T.6	T.7	T.8	T.9
3 Low F	C.0	C.1	C.2	C.3	C.4	C.5	C.6	C.7	C.8	C.9
4 Onset at	Off	On	Off	On	Off	On	Off	On	Off	On
5 Off H/C	Off	On	Off	On	Off	On	Off	On	Off	On
6 Pre Delay	0.0	0.1	0.2	0.3	0.4	0.5	0.6	0.7	0.8	0.9
7 Length	0.0	0.1	0.2	0.3	0.4	0.5	0.6	0.7	0.8	0.9
8 MIDI Ch	1	2	3	4	5	6	7	8	9	10
9 MIDI Dy	1	2	3	4	5	6	7	8	9	10
10 MIDI Ch	1	2	3	4	5	6	7	8	9	10
11 MIDI Dy	1	2	3	4	5	6	7	8	9	10
12 MIDI Ch	1	2	3	4	5	6	7	8	9	10
13 MIDI Dy	1	2	3	4	5	6	7	8	9	10
14 MIDI Ch	1	2	3	4	5	6	7	8	9	10
15 MIDI Dy	1	2	3	4	5	6	7	8	9	10

We have highlighted those parameters in the Edit matrix which have been assigned to the Soft Row of **P 0.0 Deep Blue**, for example: **Pre Delay**, and **Control 1** (named **StereoWidth** in the Soft Row).

Modifying the Soft Row, or creating a completely new Soft Row for an effect is easy:

1. From the full Edit matrix, press **Up** until you get to the Soft Row, indicated by an **S** in the lower left corner of the display.
2. With any Soft Row parameter displayed, press and hold down the **Edit** button. The following display will appear briefly.

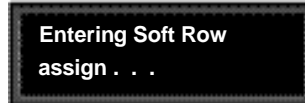

When you release the **Edit** button, the display will change to the Soft Row Assignment display shown below. The **Edit** button LED will begin flashing and will continue to flash as long as you are in Soft Row Assign.

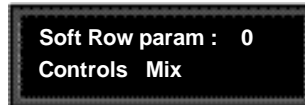

Here we show the first Soft Row parameter in our example — the actual Soft Row parameter selected will correspond to whichever one was displayed when you pressed and held **Edit**.

3. Turn ADJUST to scroll through all of the available parameters in the Edit matrix row by row, in numerical order. The entry "available" can be selected (at the fully counterclockwise position of ADJUST) to indicate that no assignment has been made at that position. Custom Controls are available for assignment at the end of the parameter list.
4. Turn SELECT to display another Soft Row position (0-9) for assignment. For each position, you can choose any effect parameter, including one(s) you have already assigned to a Soft Row position.
5. When you have arranged the Soft Row assignments as you want them, press **Edit** to exit Soft Row Assign and return to your last position in the Edit matrix. Pressing **Up** or **Down** once will also cause you to exit Soft Row Assign. Another push of either of these buttons will move you vertically through the Edit matrix.

When you return to **Go** mode, you will see the parameters in the order you assigned them — the spaces from any unassigned row positions will not appear.

Patching

Patching is the ability to assign a control (Source) to any PCM 90 parameter (Destination). This allows you to alter the value of the parameter by manipulating the control Source. For example, you can select the front panel ADJUST knob as a Source and an effect's Mix parameter as a Destination. This simple patch will allow you to dynamically alter the mix of the effect whenever you turn ADJUST. You can create as many as 10 patches, each with as many as 8 pairs of pivot points. You can patch multiple parameters to a single controller, or patch multiple Sources to a single Destination.

About Sources

All Sources are the same in the sense that each generates an output value in the range of 0-127. The output value is used to increase or decrease the setting of a Destination parameter. Sources differ in the manner in which they generate an output. Some generate values continuously (they're always "on"); some generate output based on the position of a particular external MIDI controller, or an external footpedal, or footswitch. Some Sources generate output based on aspects of physical performance such as how loud, how fast, or how hard you play. The PCM 90 allows you to choose from a selection of Sources as shown for each Destination. A list of the available Sources is shown on the following page.

The Patch Row

Each PCM 90 effect has an identical Patch row in its Edit matrix where you can make as many as 10 patches.



To make a patch, use SELECT and the **Down** button to move down through the Edit matrix to the Patch row. A display such as the following will appear.

The asterisk (*) indicates that Sources will be selected when you turn ADJUST. Press **Load/*** to change the selection to **Dst**. Press **Load/*** again to bring up the Values display where you can select **Src Value** and **Dst Value**.

SELECT will move you across the Patch row (0-9).

The Source type is indicated here. (Int, MIDI or 001-119 to indicate a MIDI Controller.)

Patch 0 *Src

Int **LFO1**

The name of the current Source assignment is shown here. (The default Source assignment is **Int...Off**.)

Pressing the **Load/*** button will change the display to allow you to sequentially select: **Src**, **Dst**, **Src Value** and **Dst Value**. Press **Up** or **Down** together with **Load/*** to backstep to the previous parameter.

Assigning a Source

Three types of sources are available: Internal, MIDI and MIDI Controller. These types are indicated in the Source list by the labels: **Int**, **MIDI**, or a number (**001-119**). Turn ADJUST to scroll through the entire list of available sources.

PCM 90 Patch Sources			
Internal		MIDI Controller Numbers	
LFO1	Latch	000	Ignored
Sine1	Sw 1	001	Mod Wheel
Cosine1	Sw 2	002	Breath
Square1	Sw 1 & 2	003	Ctl 3
Sawtooth1	Delay	004	Foot Ctl
Pulse1	S&Hold	005	PortaTime
Triangle1	Mono Lvl	006	Data Entry
Random1	Left Lvl	007	Volume
LFO2	Right Lvl	008	Balance
Sine2	FootPedal	009	Ctl 9
Cosine2	Foot Sw 1	010	Pan
Square2	Foot Sw 2	011	Xpression
Sawtooth2	ADJUST	012	Effect 1
Pulse2	Custom 1	013	Effect 2
Triangle2	Custom 2	014	Ctl 14
Random2	Custom 3	015	Ctl 15
Env L	Custom 4	016	General 1
Env R	Tempo	017	General 2
Env L+R	On	018	General 3
AR Env	Off	019	General 4
		020	Ctl 20
	
		031	Ctl 31
		(PCM 90 interprets 032 as Bank Select)	
		033	Ctl 33
	
		063	Ctl 63
		064	Sustain
		065	Porta On
		066	Sostenuto
		067	SoftPedal
		068	Legato
		069	Hold 2
		070	Sound Var
		071	Timbre
		072	Release
		073	Attack
		074	Bright
		075	Sound 6
		076	Sound 7
		077	Sound 8
		078	Sound 9
		079	Sound 10
		080	General 5
		081	General 6
		082	General 7
		083	General 8
		084	Porta Ctl
		085	Ctl 85
	
		090	Ctl 90
		091	FX1 Depth
		092	FX2 Depth
		093	FX3 Depth
		094	FX4 Depth
		095	FX5 Depth
		096	Data Inc
		097	Data Dec
		098	NRPN LSB
		099	NRPN MSB
		100	RPN LSB
		101	RPN MSB
		102	Ctl 102
	
		119	Ctl 119

Assigning a Destination

Once you have selected a Source, press **Load /*** and the display will change to allow you to assign a Destination (**Dst**).

The asterisk (*) indicates that Destinations will be selected when you turn ADJUST. Press **Load /*** to bring up the Values display where you can assign **Src Value** and **Dst Value**. Press **Load /*** again to return to Source selection, etc.

SELECT will move you across the Patch row (0-9).

The Edit matrix row label for the currently assigned parameter is shown here.

Patch 0	*Dst
Reflect	Lvl L

The name of the current Destination assignment is shown here. (***Unassigned*** will appear across the bottom display line if no assignment is selected.)

Turn ADJUST to scroll through all of the parameters in the Edit matrix of the currently loaded effect, including the Modulation parameters.

Once you have assigned a parameter as a Destination, the controller you have assigned “owns” that parameter. Adjustments made to this parameter from the Edit matrix, will only affect the initial value of the parameter when the program is loaded.

The behavior of the parameter on program load is determined by the setting of the Patch Update parameter in Control mode (1.7). This parameter can be set to **Immediate** or **Delayed**.

When **Immediate** is selected, the initial value of the parameter value will correspond to the controller position.

When **Delayed** is selected, the stored value of the parameter will continue to be in effect until the controller is moved. (It is, therefore, a good idea to set a sensible value to the parameter in the Edit matrix.)

Mod Row parameters that can be assigned as Patch Destinations	
LFO1	Rate, Shape, P Width, Depth
LFO2	Rate, Shape, P Width, Depth
AR ENV	Attack, Release, Mode
Env L	Release
Env R	Release
Sw 1	Rate, P Width, Mode
Sw 2	Rate, P Width, Mode
Delay	Delay Time

Assigning Values

Once you have assigned a Destination, press **Load /*** to get to the **Values** display.

The current **Dst** value is displayed here. When you press **Load /*** again, the asterisk will move to indicate that this value is available to be changed by turning ADJUST.

Src values are shown here. The asterisk (*) indicates that this field is available for control with the ADJUST knob (and that additional parameters are available by pressing **Load /***).

This display allows you to assign Destination values to specific Source values. These assignments are made in pairs, each with a value for the Source and a value for the Destination. For example, the default is two pairs mapped as follows:

- minimum Src value (0) = minimum Dst value
- maximum Src value (127) = maximum Dst value

This establishes a linear relationship between the parameter and the controller. Inverse control is accomplished easily by reversing these settings. As many as eight pairs of Destination/Source values, or pivot points, can be assigned here, providing an exciting new level of dynamic control.

Jump

When creating patches, there are situations in which you will want to leave the Patch row to adjust parameters. To make this convenient, a *Jump* command is available. Jumping is dependent on the current Patch display, and is activated simply by pressing **Edit** while a certain display is active. This will jump you out of the Patch row and to the location where you can make the necessary adjustments. Pressing **Edit** again will jump you back to the Patch Row. (Note that using any front panel controls other than those required to adjust the parameter to which you have jumped, will disable the jump. This is not catastrophic, but it will require you to return by using **Up** and **Down** and **SELECT**.) The following Jumps are available:

From the Patch row **Src** display:

- With ADJUST or Custom 1-4 selected as the Source, press **Edit** to jump to the Controls row, where you can specify range limits. Press **Edit** again to return to the Patch row.
- With any modulation parameter selected as a Source, press **Edit** to jump to the Modulation row position of the Source. For example, if the Patch source **LFO** is displayed, press **Edit** to jump to Modulation row position 0 (LFO) where you can edit any LFO parameter value. Press **Edit** again to return to the Patch row.

From the Patch row **Dst** selection display:

- Press **Edit** to jump to the Edit controls for the parameter you have selected as the Destination. You will have complete access to all parameter controls, including any subparameters at that location. Press **Edit** again to return to the Patch row.

From the Patch row **Values** display:

- Press **Edit** to jump to the next **Src** or **Dst** value. Default values are 0...minimum, 127...maximum.

Patching Examples

The following examples illustrate how to create a patch, use the patch jump features, modify the default patch values and add an additional pivot point to the example patch values.

Creating a patch with default values

Load program **P0 0.0 Deep Blue**. Press **Edit** to enter Edit mode, then press **Up** to move to the Patch Row. Press **Load/*** until the display looks like this:



Turn SELECT to select Patch 2 (which is set to **Off**).



Turning ADJUST will scroll through the entire list of available patch Sources. Turn ADJUST counterclockwise until **LFO1** is displayed in the lower right.



LFO1 is now assigned as a patch Source.

Press **Load/*** to bring up patch Destinations for selection. The display should show that Destination is unassigned.



The ADJUST knob will now scroll through all of the available parameters of **Deep Blue**. The lower line of the display will show the edit matrix row label on the left, and the parameters in that row on the right.

Turn ADJUST clockwise until **High Cut** (in the effect's Design row) is displayed in the lower right corner of the display.



The High Cut parameter is now assigned as the patch Destination.

Now, press **Load/*** to bring up the Values display. This will show the default Destination value setting (0.1kHz). This is the value assigned to High Cut when LFO1 is at its minimum value (000).



Turn ADJUST one click counterclockwise to display the default Destination value (FLAT) assigned to High Cut when LFO1 is at its maximum value (127).

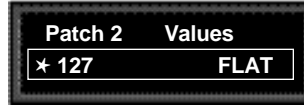

That's all there is to setting up a default patch— select a Source and Destination, and the minimum and maximum patch values are set automatically.

Of course, you will often want to modify the patch further, either by adjusting the modulation source parameters, changing the default values or adding additional pivot points. In the following sections, we'll continue using this patch to demonstrate examples of these modifications. When we're done, the new patch will add dynamic spatialization to the Deep Blue program.

Adjusting the modulation source parameters

Continuing the previous example, we'll adjust the rate of LFO1 by jumping to it from the Patch row.

Press **Load/*** repeatedly to return to the Patch 2 Source selection display.



Press **Edit** to jump directly to the LFO1 parameters in the Mod row.

The asterisk (*) indicates that LFO1 **Rate** will be altered when you turn ADJUST. Press **Load/*** to change the selection to the other LFO1 parameters (**Shape**, **P Width** and **Depth**).



The display now shows position 5.0 in the Edit matrix Mod Row.

Turn ADJUST to change the rate of LFO1 to **0.30Hz**.



Now, press **Edit** to jump back to your previous position in the Patch row.



Changing the default destination values

Let's modify the patch further by adjusting the Destination values to a more useful range.

Press **Load/★** repeatedly until the Patch 2 Values screen is displayed.

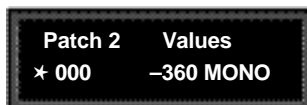

Notice that the ★ is to the left of the Source value. This indicates that the Source value is selected and its value will be changed when you turn ADJUST.

Press **Load/★** once to move the ★ to the right of the Source value. When the ★ is in this position, ADJUST will change the Destination value.

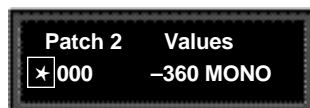

The asterisk (★) indicates that the Source value will be altered when you turn ADJUST.

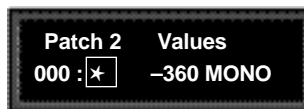

Press **Load/★** to move the asterisk to this position, where it indicates that Destination values will be altered when you turn ADJUST.

With the Destination value selected, turn ADJUST clockwise to set the value to **+0**.

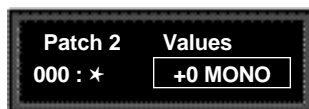

Next, we'll want to adjust the Destination value when LFO1 is at its maximum value. One way to do this is to press **Load/★** three times to cycle the ★ to the display of the Source value, and continue on from there — but we've provided a short cut! Press **Edit** to jump to the next assigned value (in our example, the maximum value for LFO1).



Note that the ★ remains in the same position, so you can just turn ADJUST to set the new Destination value. Set the value to **+90**.

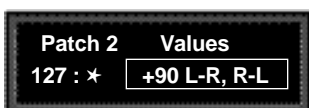

Now our example has been modified so that LFO1 sweeps the Out Width Value from 0 to 90. This creates a dynamic alteration of the effect's spatial characteristics. Its stereo image changes smoothly from mono to stereo, to surround, and back again.

Adding an additional pivot point to the patch

So far, our example uses only two pairs of patch values. The Destination parameter moves linearly between the value assigned at 000 and the value assigned at 127.

You can watch this change by displaying the Destination parameter. Here's how to jump directly to it from the patch:

Press **Load/★** repeatedly to return to the Patch 2 Destination selection display.

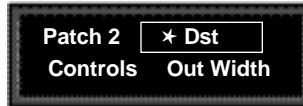

Press **Edit** to jump directly to the Out Width parameter in the Controls Row.



The Out Width value will be changing from 0 to 90 and back again.

The display will change to show position 0.3 in the Controls Row. Note that the value is changing continuously from 0 to 90 and back again. Notice also the small square in the upper right corner of the display. This patch destination indicator appears whenever a parameter has been assigned as a patch Destination in the effect being edited.

Now let's return to the Patch row to add a pivot point to the effect.

Press **Edit** to jump back to the Patch row.

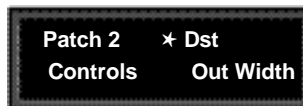

Press **Load/★** to bring up the Values display. The last value edited will be displayed, so you will see *either* the minimum or maximum value.



OR

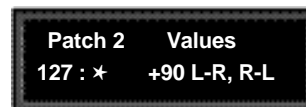

If the ✱ is not at the left of the Source value, press **Load/✱** three times to move it there. (You can take a short cut instead — simultaneously press **Down** and **Load/✱** to back-step.)

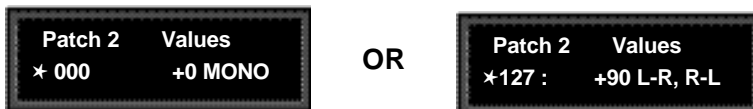

Turn ADJUST to display **64**. This will be the Source value of our new pivot point. The string of dots in the destination value portion of the display indicate that there is no Destination value assigned when the source value is 64.



Press **Load/✱** to move the ✱ to the right of the Source value, and turn ADJUST clockwise to set the Destination value for this point to **-45**.



By adding this pivot point, we have put a “kink” in the patch. The value of the Destination parameter no longer moves in a straight line between 0 and 90. Instead it moves from 0 to -45, and then from -45 to 90. This will produce a very different sounding spatial change from the original patch. You can see the difference by pressing **Load/✱** twice to display the patch Destination, then pressing **Edit** to jump back to the Destination parameter to watch its value change.

Multiple Patches with the Same Destination

If you create two or more patches with the same Destination, the Destination value will be the sum of all of the patches assigned to it.

For example, if Footpedal and ADJUST are both assigned to Mix, the Mix value will be the sum of the patch Destination values for those two patches. When creating multiple patches to the same Destination, you should set the individual Destinations to values which, when added together, are less than or equal to the maximum value for the parameter. Footpedal and ADJUST, for example, could each have a maximum value of 50%, or they could be assigned values of 25% and 75%, 60% and 40%, etc.

When the sum of multiple patched parameter Destination values is greater than the maximum value of the parameter, the parameter value will remain at maximum until the sum of the patches falls below it.

Mod Row Patches

AR ENV, **Latch**, **Sw 1**, **Sw 2**, **Delay** and **S&Hold** are each activated by assigning a threshold source to **T Src** that is used to turn them on and off. This assignment is a subparameter in the Mod row — not in the Patch row.

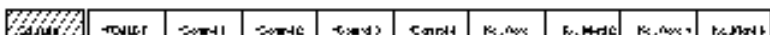

The Custom Row

The Custom row of the full edit matrix allows you to customize an effect by adding defining ranges, as well as adding meaningful names and labels to the ADJUST knob and the Custom Controls. It also provides controls for assigning KeyWords to effects for sorting purposes.

Setting Range Limits for ADJUST and the Custom Controls

The first five positions in the Custom row: **ADJUST** and **Control 1-4** allow customization of the ADJUST knob and any Custom Controls you want to place in the Soft Row. The controls for each of these behave identically.

The first set of controls allows you to set range limits. Press **Load/*** and turn SELECT to display **Low Limit**, **High Limit** and **MidPoint**. Use ADJUST to select values from 0-127.

Low Limit is the minimum value that the control will output. In most cases this will be 0 (or 127 for inverted control). If ADJUST or the Custom Control is also mapped to a MIDI controller, incoming MIDI values below this minimum value will be treated as equivalent to the Low Limit.

High Limit is the maximum value that the control will output. This can be set to any value above the Low Limit and effectively establishes the total range of the controller. If ADJUST or the Custom Control is also mapped to a MIDI controller, MIDI values above this maximum value will be treated as equivalent to the High Limit.

In many cases, where the control is to have full range (0-127) or where it is to behave as an off/on switch (0-1) these two values (Low and High) are the only ones which have to be specified. In other cases, the control can be enhanced by adding more than just these simple range limits.

MidPoint allows you to establish a fixed reference point between the Low and High Limits you have selected. The MidPoint has no effect on the range you have established, but does determine the number of positions within the controller's range which can be labeled with text.

Labeling ADJUST, the Custom Controls and their ranges

Press and hold down the **Edit** button to access a submode which allows you to name the control, as well as any points you have assigned. While you are holding down **Edit**, the message: **Entering Custom label assign ...** will be displayed, followed by the current name of the control with a cursor positioned over the first character of the name. Use ADJUST to select a new character. Press **Up** or **Down** to select a new *type* of character (upper case, lower case, numeric, symbolic, or blank). Simultaneously press **Up** and **Down** to clear all characters from the cursor to the end of the line. Turn SELECT to move the cursor to a new position. Continue in this manner until you have finished entering the new name. A maximum of 20 characters (including spaces) may be used.

Press **Load/*** repeatedly to cycle through the remaining choices: **LowLabel**, **HighLabel**, **MidLabel**, **LowRange** and **HighRange**. Names are entered using ADJUST and SELECT in exactly the same manner.

PCM 90 Character Set	
!"#\$%&'()*+,-./012345	
6789:;<=>?@ABCDEFGHIJ	
KLMNOPQRSTUVWXYZ[\]^_`	
abcdefghijklmnopqrstuvwxyz{ }~■	
(space)	

The @ and the \$ symbols are used to represent Custom Control values.

LowLabel: The name you assign will appear on the bottom line of the display when the control reaches the value you have set as the Low limit.

HighLabel: The name you assign will appear on the bottom line of the display when the control reaches the value you have set as the High Limit.

MidLabel: The name you assign will appear on the bottom line of the display when the control reaches the value you have set as the MidPoint. (This naming display is not available if you have not assigned a MidPoint within the range established by the Low and High Limits.)

LowRange: The name you assign here will be displayed whenever the controller is between the MidPoint and the Low Limit.

HighRange: The name you assign here will be displayed whenever the controller is between the MidPoint and the High Limit.

You can display numerical values anywhere along the bottom line of the display by entering the characters @ or \$ where you want values to appear. As many as three digits can be displayed, representing absolute distance from the Low Limit (@@@), or relative distance from the selected MidPoint (\$\$\$). If the MidPoint is at or below the Low Limit, this range will be equivalent to the entire range of the controller. The default status of the label displays includes @@@ already entered at the beginning of the entry line. Check out the presets in the Custom row of any bank for examples of Custom Controls.

Assignable KeyWords	
Acoustic	Medium
Ambience	MIDI
Ballad	Mono
Bright	Natural
Broadcast	Orchestral
Cascade	Outdoor
Chamber	Plate
Classical	RandomHall
Cncrt Hall	Room
Custom	Short
Dark	Slap FX
Dialog	Small
Drums/Perc	Spatial
Dynamic	Special FX
Echo	Splits
Film-ADR	Stereo
Gated	Surround
Guitar	Tempo
Indoor	Unnatural
Instrument	Vocal
Keyboard	User 1
Large	User 2
Live PA	User 3
Long	User 4
Mastering	

Assigning KeyWords to an Effect

The last four positions of the Custom row allow as many as four KeyWords to be assigned to the current effect. At each position (**Keyword 1-4**), use ADJUST to select a representative Keyword from the list shown in the sidebar — or "none".

Effect sorting by Keyword is accomplished in Control mode at location 1.8. To view the sorted list, repeatedly press either **Program Banks** or **Register Banks** through all of the available banks, then to the Keyword display. In Control mode, **A to Z** is available as a viewing selection. All effects are internally tagged to allow this option of alphabetical sorting.

3

The Algorithms and Their Parameters

The PCM 90 uses five algorithms to create different types of reverberation effects. Each of these algorithms and its associated parameters are described in detail in this section.

When you select any effect, the bank and row label will appear on the upper display line. The matrix location and the effect name will appear on the lower line. Press and hold **Program Banks** or **Register Banks** to display the algorithm from which the currently loaded effect is derived. Press **Edit** to display the last edited parameter in that algorithm's parameter matrix.

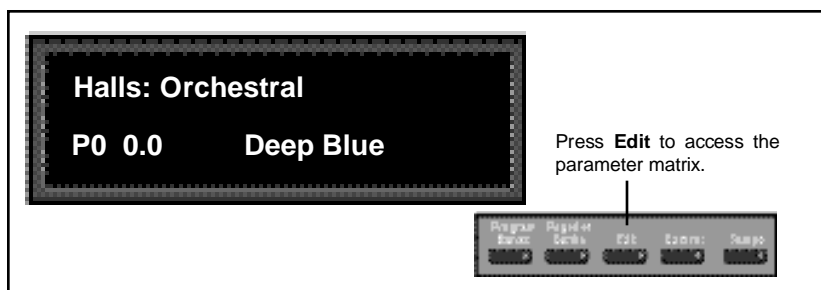

The five PCM 90 algorithms, Random Hall, Ambience, Rich Plate, Concert Hall and Chamber/Room, share the same general structure, shown below. The shaded area of the diagram is detailed in the individual effect descriptions that follow.

About the Algorithms

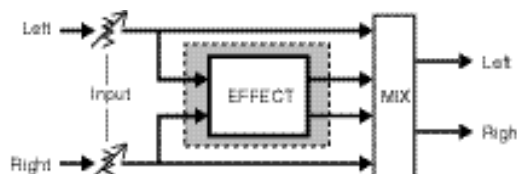

The five algorithms share a common set of controls and parameters built around one of the five stereo reverb effects.

Input levels and hardwired pans determine the signal flow to left and right pairs of delay voices, and also to the reverb effect. Some delay voices have individually adjustable level, delay, and feedback controls, as well as master voice controls. A **High Cut** parameter provides high end rolloff. **InWidth** and **OutWidth** controls allow the creation of spatial effects.

In this chapter, diagrams and descriptions of each algorithm are presented first, along with pictures of each edit matrix. The diagrams are followed by a glossary of parameter descriptions, organized alphabetically by matrix row name. Within each matrix row, parameters are organized as far as possible in the sequence in which they appear in the row.

Random Hall The Random Hall algorithm gives recorded music a sense of being performed in a real acoustic location. The Size, Spread and Shape controls allow adjustment of the buildup and decay of the initial part of the reverberation envelope. Shape controls the shape of the envelope, while Spread and Size set the time over which this shape is active.

Size acts as a master control for the apparent size of the space being created. Both Spread and Reverb Time vary *linearly* with the setting of Size. Thus maximum reverb time and spread require high settings of Size. To find an appropriate reverb sound, start with a preset with a similar sound to what you want to end up with, turn ADJUST to see what effect it has, then investigate the parameters, starting with Size. Until you are familiar with the PCM 90, we recommend that you edit any patch driving a parameter rather than editing the parameter directly.

Once a size has been selected, Spread and Shape are used to adjust the shape and duration of the initial reverb envelope, which together provide the major sonic impression of room size.

When Shape is at minimum, the reverberation envelope builds up very quickly to a maximum amplitude, and then dies away quickly at a smooth rate. This envelope is characteristic of small reverberation chambers and reverberation plates. There are few (if any) size cues in this envelope, so it is ineffective in creating ambience. With this Shape setting, Spread has no effect. The density is set by the Size control, and the rate of decay is set by the reverb time controls.

As Shape is raised to about 1/8 of its range, the initial sharp attack of the reverberation is reduced, and reverberation builds more slowly. The envelope then sustains briefly before it begins to die away at the rate set by Mid Rt. Spread has little or no effect on this shape. When Shape is at 1/4 of its range, buildup is even slower and the sustain is longer. Now Spread affects the length of both the buildup and the sustain. As a rough estimate, the sustain will be approximately the time value indicated by the Spread display (in milliseconds).

As Shape is raised further, the buildup and sustain remain similar, but now a secondary sustain appears in the envelope, at a lower level than the first. This secondary plateau simulates a very diffused reflection off the back wall of a hall, and is effective in creating a sense of size and space. This reflection becomes stronger and stronger, reaching an optimal loudness when Shape is at about 1/2 of its range.

The highest Shape settings are typically used for effects. Near the top of the scale the back wall reflection becomes stronger than the earlier part of the envelope, resulting in an inverse sound.

Note that none of these shape effects are audible unless Mid Rt is set short enough. Generally, this control should be set to a value of about 1.2 seconds for small rooms, and up to 2.4 seconds or so for halls. Size should also be set to a value appropriate to the desired hall size (note, however, that small sizes color the reverberation). 15 meters makes a very small room, and 38 meters is useful for a large hall.

Random Hall incorporates random delay elements which have several effects. First, there is a reduction of long-lived modes in the reverberant decay, which makes the decay less metallic and reduces the apparent reverb time. The random elements also improve the steady-state timbre of the program.

The speed at which the delay elements move is controlled by Spin. Values of Spin which are higher than about 40% can cause audible pitch wobble in very critical material (such as classical guitar or piano) and can also cause noise on pure tones. This noise is not audible in speech, however, and, for mixed music or speech, values up to 50% will give an improved sound. Wander is typically set to about 10ms at larger settings of Size. Smaller values of Wander should be used when smaller Sizes are used.

This algorithm also offers the option of adding early reflections which have been made into diffused clusters of pre-echoes. The density of the cluster is set by the Diffusion control. We recommend that these pre-echoes be used with caution, unless you are trying to match the sound of the reverberation to a particular location where such reflections are strong.

An output width control affects the stereo image of the signal leaving the reverb effect. OutWidth can add width to a signal, or move a reverb into a surround channel. Either control can be used statically or dynamically, but in certain positions may be mono-incompatible.

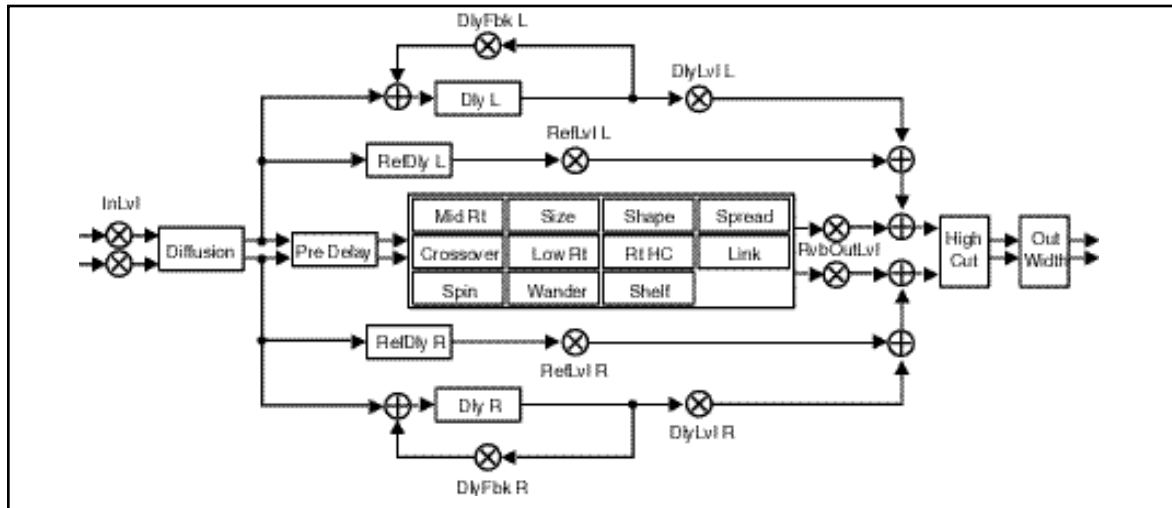

0	Controls	0.0 Mix	0.1 In Lvl	0.2 RvbOutLvl	0.3 OutWidth					
1	Time	1.0 Low Rt	1.1 MidRt	1.2 Crossover	1.3 Rt HC	1.4 Pre Delay	1.5 Shelf			
2	Design	2.0 Size	2.1 Diffusion	2.2 Shape	2.3 Spread	2.4 Spin	2.5 Wander	2.6 Link	2.7 High Cut	
3	Reflect	3.0 *Mstr DlyLvl	3.1 *DlyLvlL	3.2 *DlyLvlR						
4	Delay	4.0 *Master	4.1 *DlyLvlFbkL	4.2 *DlyLvlFbkR						
5	Modulation	5.0 *ModLFC1	5.1 *ModLFC2	5.2 *ModLR Env	5.3 *ModFollow	5.4 *ModLatch	5.5 *ModBW1	5.6 *ModBW2	5.7 *ModDelay	5.8 *ModS&Hold
Patch		Patch 0	Patch 1	Patch 2	Patch 3	Patch 4	Patch 5	Patch 6	Patch 7	Patch 8
Custom		*ADJUST	*Control 1	*Control 2	*Control 3	*Control 4	KeyWord 1	KeyWord 2	KeyWord 3	KeyWord 4

Ambience While Random Hall effects are designed to add a cushion of reverberance to recorded music, while leaving the clarity of the direct sound unaffected, Ambience is intended to become a part of the direct sound — to give it both better blend and a definite position in space. Ambience gives warmth, spaciousness and depth to a performance without coloring the direct sound at all.

This algorithm generates primarily the strong reflections which appear in the first few hundred milliseconds of the reverberation process. These early reflections constitute the primary audible effect, giving you the impression of a hall surrounding you while the music is playing. To avoid any coloration from these strong reflections, the time delays and amplitudes are random functions.

Ambience is very useful for adding a room sound to recorded music or speech. It is particularly easy to match a studio recording of dialog to a typical room environment. In music recording, it allows you to realistically add distance to a close-miked signal. If an ensemble has been recorded with close-mikes and pan pots, Ambience can provide the missing blend and depth. The apparent position of the instruments is preserved in the reverb while the apparent distance is increased. This algorithm is also useful in matching a closely miked accent microphone to the overall ambience of a recording. This allows a soloist to be increased in level without changing the apparent distance. Ambience can be used in a recording situation any time a close-miked sound is undesirable.

To use the algorithm with a console, it is best to use a stereo send to the PCM 90, carefully matching the panning of the various close-miked sources to their positions in the mix. Leave the Mix control at 100%. The apparent distance of each source can be controlled by the level of its feed.

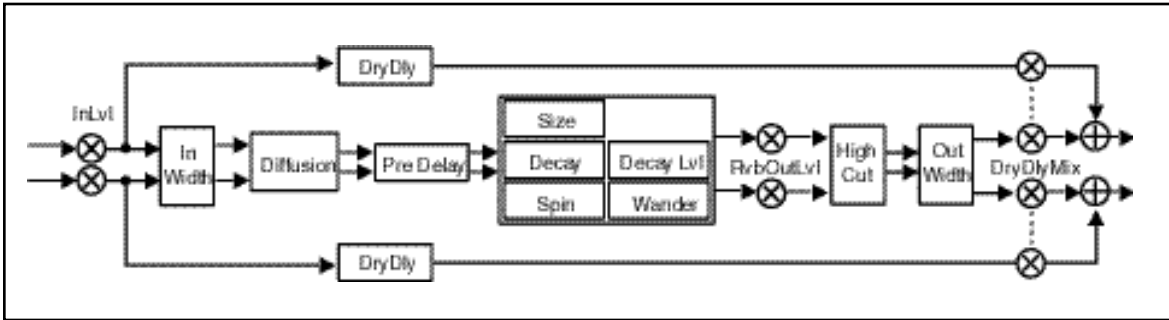

0	Controls	0.0 Mix	0.1 In Lvl	0.2 InWidth	0.3 RvbOutLvl	0.4 OutWidth					
1	Time	1.0 Decay	1.1 DecayLvl	1.2 Pre Delay	1.3 DryDly	1.4 DryDlyMix					
2	Design	2.0 Size	2.1 Diffusion	2.2 Spin	2.3 Wander	2.4 High Cut					
3	Modulation	3.0 *ModLFO1	3.1 *ModLFO2	3.2 *ModAR Env	3.3 *ModFollow	3.4 *ModLatch	3.5 *ModSW 1	3.6 *ModSW 2	3.7 *ModDelay	3.8 *ModSSHold	
Patch		Patch 0	Patch 1	Patch 2	Patch 3	Patch 4	Patch 5	Patch 6	Patch 7	Patch 8	Patch 9
Custom		*ADJUST	*Control 1	*Control 2	*Control 3	*Control 4	KeyWord 1	KeyWord 2	KeyWord 3	KeyWord 4	

The Rich Plate algorithm mimics the sound of metal plates. It has a dense, smooth, colored sound that makes it a good choice for enhancing any type of percussion. Larger sizes and longer reverb times are particularly effective on vocals and brass, but this algorithm can be optimized for use on virtually any source.

Rich Plate

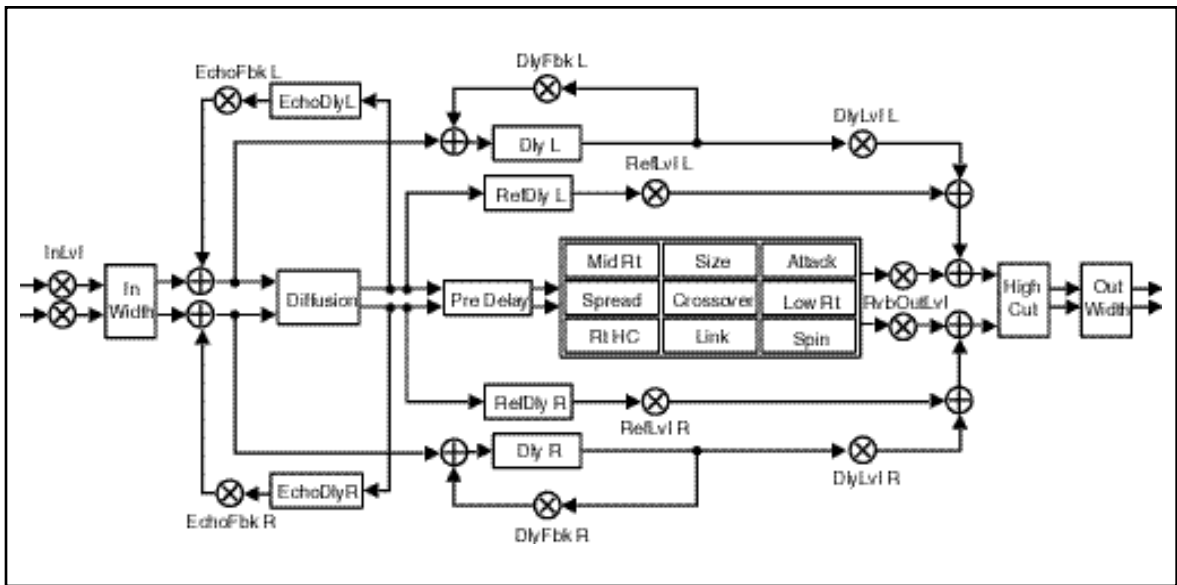

0	0.0	0.1	0.2	0.3	0.4					
Controls	Mix	In Lvl	In Width	RvbOutLvl	Out Width					
1	1.0	1.1	1.2	1.3	1.4					
Time	Low Rt	Mid Rt	Crossover	Rt HC	Pre Delay					
2	2.0	2.1	2.2	2.3	2.4	2.5	2.6			
Design	Size	Diffusion	Attack	Spread	Spin	Link	High Cut			
3	3.0	3.1	3.2							
Reflect	*Matr DlyLvl	*DlyLvl L	*DlyLvl R							
4	4.0	4.1	4.2							
Echo	*Mat DlyFbk	*DlyFbk L	*DlyFbk R							
5	5.0	5.1	5.2							
Delay	*Master	*DlyLvlFbk L	*DlyLvlFbk R							
6	6.0	6.1	6.2	6.3	6.4	6.5	6.6	6.7	6.8	
Modulation	*ModLFO1	*ModLFO2	*ModAR Env	*ModFollow	*ModLatch	*ModSw 1	*ModSw 2	*ModDelay	*ModSMHold	
Patches	Patch 0	Patch 1	Patch 2	Patch 3	Patch 4	Patch 5	Patch 6	Patch 7	Patch 8	Patch 9
Custom	*ADJUST	*Control 1	*Control 2	*Control 3	*Control 4	KeyWord 1	KeyWord 2	KeyWord 3	KeyWord 4	

Concert Hall This algorithm emulates a real concert hall. The reverberation is very clean, and designed to remain behind the direct sound — adding ambience, but leaving the source unchanged. This effect has a relatively low initial echo density which builds up gradually over time.

This algorithm also features a post-verb compressor which can be used to shape the reverb tail in unusual ways. Spatial EQ controls, following the compressor, can be used to widen or narrow low-frequency stereo separation. A dry signal path allows you to process material with or without reverberation. This is useful in live recordings.

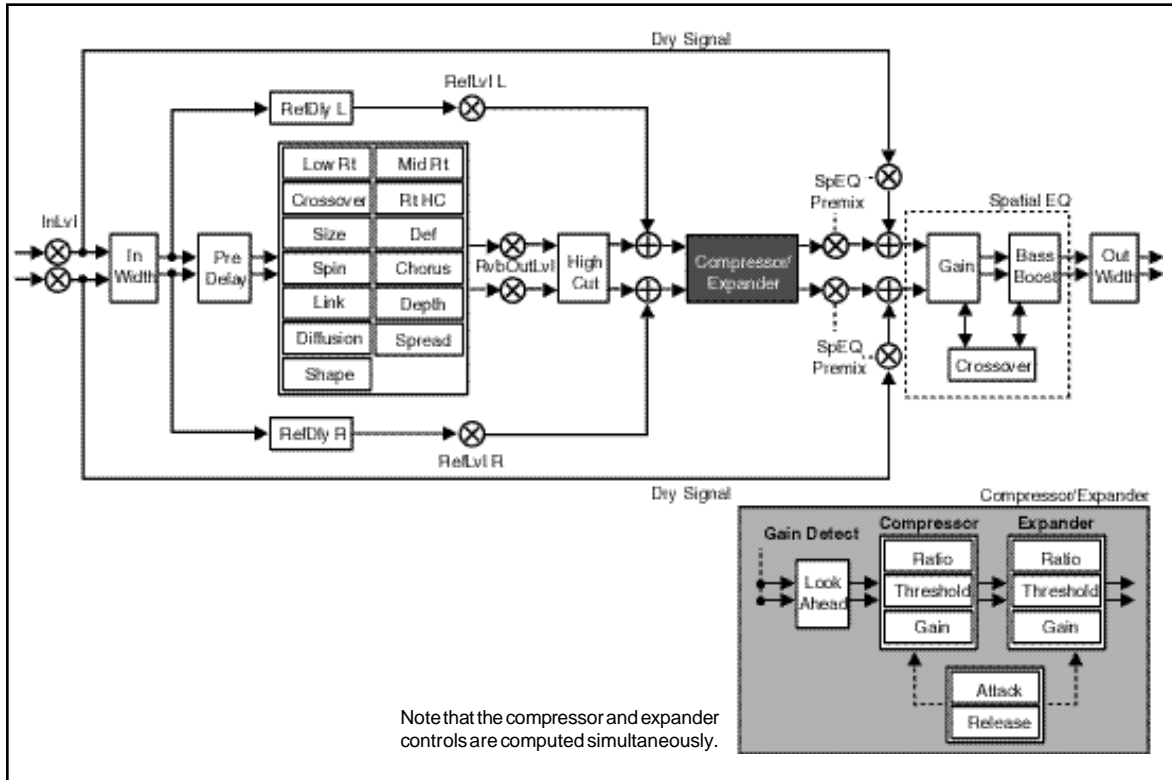

0	Controls	0.0 Mix	0.1 In Lvl	0.2 InWidth	0.3 RvbOutLvl	0.4 OutWidth					
1	Time	1.0 Low Rt	1.1 Mid Rt	1.2 Crossover	1.3 Rt HC	1.4 Pre Delay					
2	Design	2.0 Size	2.1 Diffusion	2.2 Shape	2.3 Spread	2.4 Def	2.5 Depth	2.6 Spin	2.7 Chorus	2.8 Link	2.9 High Cut
3	Reverb	3.0 *Mix DryLvl	3.1 *DryLvl L	3.2 *DryLvl R							
4	Compress	4.0 Ratio	4.1 Threshold	4.2 Gain	4.3 LookAhead	4.4 Attack	4.5 Release				
5	Expand	5.0 Ratio	5.1 Threshold	5.2 Gain							
6	Spatial EQ	6.0 Premix	6.1 Crossover	6.2 Gain	6.3 BassBoost						
7	Modulation	7.0 *ModLFD1	7.1 *ModLFD2	7.2 *ModAR Env	7.3 *ModFollow	7.4 *ModLatch	7.5 *ModSw 1	7.6 *ModSw 2	7.7 *ModDelay	7.8 *ModSMHold	
	Patches	Patch 0	Patch 1	Patch 2	Patch 3	Patch 4	Patch 5	Patch 6	Patch 7	Patch 8	Patch 9
	Custom	*ADJUST	*Control 1	*Control 2	*Control 3	*Control 4	KeyWord 1	KeyWord 2	KeyWord 3	KeyWord 4	

This algorithm provides two independent reverbs which can be used in mono in/ stereo out, or stereo in/stereo out configuration. Chamber provides an even, relatively dimensionless reverberation, with little change in color as the sound decays. Its unobtrusive character makes it useful on a wide range of program material. Room produces an excellent simulation of a very small room which is useful for dialog and voiceover applications, but which may be too colored for some sustained musical tones. Increasing the Size/Shape/Spread parameters produces an excellent reverb and an Infinite control allows you to freeze a signal for as long as you like. The outputs of the two reverbs are summed into a single stereo output.

Chamber/Room

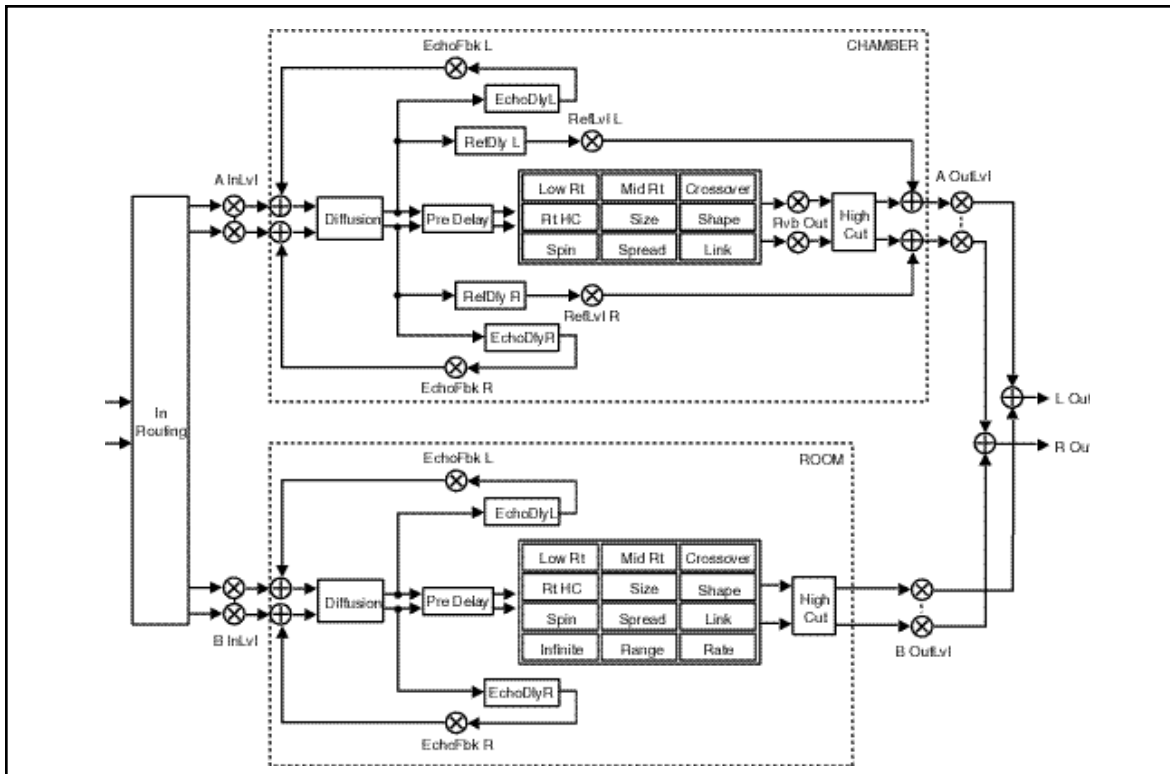

0 Controls	0.0 Mix	0.1 *InRouting	0.2 A InLvl	0.3 A OutLvl	0.4 B InLvl	0.5 B OutLvl					
1 Time: A	1.0 Low Rl	1.1 Mid Rl	1.2 Crossover	1.3 Rt HC	1.4 Pre Delay						
2 Design: A	2.0 Size	2.1 Diffusion	2.2 Shape	2.3 Spread	2.4 Spin	2.5 Link	2.6 High Cut	2.7 Reverb Out			
3 Reflect: A	3.0 *Matr DlyFbk	3.1 *DlyLvl L	3.2 *DlyLvl R								
4 Echo: A	4.0 *Matr DlyFbk	4.1 *DlyFbk L	4.2 *DlyFbk R								
5 Time: B	5.0 Low Rl	5.1 *Mid Rl	5.2 Crossover	5.3 Rt HC	5.4 Pre Delay	5.5 Infinite					
6 Design: B	6.0 Size	6.1 Diffusion	6.2 Shape	6.3 Spread	6.4 Spin	6.5 Link	6.6 High Cut	6.7 Range	6.8 Rate		
7 Echo: B	7.0 *Matr DlyFbk	7.1 *DlyFbk L	7.2 *DlyFbk R								
8 Modulation	8.0 *ModLFO1	8.1 *ModLFO2	8.2 *ModAR Env	8.3 *ModFollow	8.4 *ModLatch	8.5 *ModSw 1	8.6 *ModSw 2	8.7 *ModDelay	8.8 *ModS&Hhold		
Patches	Patch 0	Patch 1	Patch 2	Patch 3	Patch 4	Patch 5	Patch 6	Patch 7	Patch 8	Patch 9	
Custom	*ADJUST	*Control 1	*Control 2	*Control 3	*Control 4	KeyWord 1	KeyWord 2	KeyWord 3	KeyWord 4		

The Parameters

PCM 90 parameters are organized into labeled rows within each edit matrix. Although there are similarities among all matrixes, such as having a row of Controls first, and Modulation, Patching and Custom Control rows last, some of the parameters within each row, and some entire rows are unique to specific algorithms.

This section contains descriptions for all PCM 90 parameters, organized alphabetically by row label as follows:

Compress
Controls
Custom
Delay
Design
Echo
Expand
Modulation
Patches
Spatial EQ
Reflect
Time

Individual parameter descriptions within each row are presented, as far as possible, in the order in which they appear from left to right in the edit matrix.

Compress Row 4 of the Concert Hall algorithm contains compression controls for a built-in compressor/expander. Remember that, in some ways, a digital compressor is the opposite of an analog compressor. An analog compressor reduces gain when the incoming signal is above a certain threshold; a digital compressor *increases* gain when the signal is *below* the threshold. The end result — lower dynamic range— is the same, but it's easy to become confused if you are familiar only with analog equipment.

Ratio

Ratio controls the slope of the gain curve or the ratio of input level versus output level.

Threshold

Threshold sets the level below which gain is increased. This should normally be set fairly high (-10dB or more).

Gain

Gain adjusts the gain of low level signals (below the compression threshold).

LookAhead

LookAhead sets the predelay of the audio before the digital VCA. If the source material has many strong transients, proper adjustment of this parameter can reduce the possibility of clipping.

Attack

Attack adjusts the attack time constant, determining how quickly the compressor responds to increasing input level. This should normally be set quite low to allow the compressor to react to sharp transients.

Release

Release allows adjustment of the release time constant, determining how quickly the compressor responds to decreasing input level. This should normally be set long. Short release times may cause an effect similar to "pumping" in an analog compressor.

Row 0 of every algorithm contains parameters that provide overall control of both the reverb and voice effects.

Controls

Mix

Mix controls the ratio of dry and wet signal present at the PCM 90 outputs. When the PCM 90 is patched into a console or an instrument amplifier through an auxiliary or effects loop, this control should always be set to 100% wet. (Control Mode 1.1 allows you to select a global Mix setting.)

In Lvl

InLvl controls the level of the unprocessed (dry) signal into the effect. The range of this parameter in the Chamber/Room algorithm is +5.0dB, to -7.2dB, to Off. In all other algorithms the range is from +6dB, to -73dB, to Off. Individual controls for the A and B effects in the Chamber/Room algorithm are labeled A InLvl and B InLvl.

RvbOutLvl

RvbOutLvl controls the output level of the reverberator before it is mixed with the dry signal and any reflections or delays. The range is from Full (0dB) to -24dB, to Off. Individual controls for the A and B effects in the Chamber/Room algorithm are labeled A OutLvl and B OutLvl.

Out Width

Out Width controls the width of the entire processed signal. This can be thought of as an extension of typical mono to stereo imaging controls. The range of this parameter is -360 to +360, in single digit increments. Values of -360, 0, or +360 cause the effect's audio output to be mono. Values of -315 and +45 cause the output to be normal left/right stereo. Values of -45 and +315 cause "swapped", or right/left stereo.

Value	Display Label	Description
360	MONO	Phase Normal Mono
315	R, L	Phase Normal R/L stereo
270	R-L, L-R	R-L, L-R surround*
225	STEREO INV	Phase Inverted L/R Stereo
180	MONO INV	Phase Inverted Mono
135	R, L INV	Phase Inverted R/L Stereo
90	L-R, R-L	L-R, R-L surround
45	STEREO	Phase Normal L/R stereo
0	MONO	Phase Normal Mono
-45	R,L	Phase Normal R/L Stereo
-90	R-L, L-R	Phase Inverted R-L, L-R surround*
-135	STEREO INV	Phase Inverted L/R Stereo
-180	MONO INV	Phase Inverted Mono
-225	R, L INV	Phase Inverted R/L Stereo
-270	L-R, R-L	L-R, R-L surround
-315	STEREO	Phase Normal L/R Stereo
-360	MONO	Phase Normal Mono

* Disappears in mono

Controls cont'd. The large and duplicated range of the Out Width parameter allows smooth glides from any Left/Right Mix, Phase, Mono/Stereo image point to any other. Of particular interest are: 0 MONO, 45 STEREO, and 90 L-R, R-L (surround channel). This parameter can be changed in real-time for fascinating spatial effects.

In Width

In Width provides a width control for the input signal before it is fed to the reverberator. Careful use of this control can provide fascinating results. For example, a setting of 45 will provide a normal stereo reverberation effect, while a setting of 90 will exclude any mono (center) signal from the reverberator. Modulation of this control can result in the illusion of various parts of the input moving forward and backward in the reverberant field.

InRouting

Available in the Chamber/Room algorithm, InRouting controls the routing of the input signal to the reverberators. MonoSplit routes the left input to the Chamber and the right input to the Room, RevMonoSplit routes the right input to the Chamber and the left input to the Room, Stereo Split routes both inputs to both the Chamber and the Room. In each case the outputs from the two reverberators are summed and sent to the stereo output of the PCM 90.

Custom The last row of each algorithm edit matrix allows customization and labeling of ADJUST, and four custom controls. It also allows the assignment of KeyWords for effect sorting.

ADJUST, Control 1, Control 2, Control 3, Control 4

These controls allow names and ranges to be specified for ADJUST and for four other Custom Controls. Press **Load/★** to display: Low Limit, High Limit and MidPoint for the displayed control. Turn ADJUST to select values from 0-127.

Low Limit: This is the lowest value that the controller will output (or accept, if connected to MIDI).

High Limit: This is the maximum value that the controller will output.

MidPoint: This allows you to set a fixed point within the range you have established between the high and low limits.

Pressing and holding **Edit** accesses a submode which allows you to name the control, as well as any points you have assigned. Pressing **Load/★** will cycle through the following choices. From any of the displays, use ADJUST to select a character for the space marked by the flashing cursor. Use SELECT to move the cursor to another position.

<p>PCM 90 Character Set</p> <p>!"#\$%&'()*+,-./012345 6789:;<=>?@ABCDEFGHIJ KLMNOPQRSTUVWXYZ [^\`_abcdefghijklmnopqrstuvwxyz { } ~ █ (space)</p> <p>The @ and the \$ symbols are used to represent Custom Control values.</p>

Name: The name you assign here will appear on the top line of the display whenever the control is adjusted.

LowLabel: The name you assign will appear on the bottom line of the display when the control reaches the value you have set as the Low Limit.

HighLabel: The name you assign will appear on the bottom line of the display when the control reaches the value you have set as the High Limit.

MidLabel: The name you assign will appear on the bottom line of the display when the control reaches the value you have set as the MidPoint (not available if you have not assigned a MidPoint within the established range.)

LowRange: The name you assign here will be displayed whenever the controller is between the Midpoint and the Low Limit.

HighRange: The name you assign here will be displayed whenever the controller is between the Midpoint and the High Limit.

You can display numerical values anywhere along the bottom line of the display by entering the characters @ or \$ where you want these values to appear. As many as 3 digits can be displayed, representing absolute distance from the the Low Point (@ @ @) or relative distance from the selected Midpoint (\$ \$ \$). If the Midpoint is at or below the Low Limit, this range will be equivalent to the entire range of the controller. The default status of the naming displays is to have @ @ @ already entered at the beginning of the entry line.

For additional information on Custom Controls, see Chapter 2: Basic Operation.

KeyWord 1-4

The last four controls in the Custom row allow assignment of as many as four KeyWords to the effect. Each of the controls behaves identically — simply turn ADJUST to select a KeyWord from the list shown in the sidebar. All effects are tagged internally for alphabetical (A to Z) sorting, but this is shown in the list for completeness. For specialized sorting, four User KeyWords are provided at the end of the list.

PCM 90 KeyWords	
A to Z	Mastering
Acoustic	Medium
Ambience	MIDI
Ballad	Mono
Bright	Natural
Broadcast	Orchestral
Cascade	Outdoor
Chamber	Plate
Classical	RandomHall
Cnrt Hall	Room
Custom	Short
Dark	Slap FX
Dialog	Small
Drums/Perc	Spatial
Dynamic	Special FX
Echo	Splits
Film-ADR	Stereo
Gated	Surround
Guitar	Tempo
Indoor	Unnatural
Instrument	Vocal
Keyboard	User 1
Large	User 2
Live PA	User 3
Long	User 4

Delay In each the Random Hall and Rich Plate algorithms, a Delay row contains parameters for delay, feedback and level settings of each voice. Press **Load/★** to cycle through selections.

You can set and display delay values in units of time, or with tempo values. Press **Up** and **Tempo** simultaneously to toggle between these two options. When time units are selected, delay times are set and displayed in milliseconds or seconds (from 0ms to the maximum available delay for that parameter). When tempo values are selected, delay values are set and displayed as a ratio of echoes to beats (from 24:1 to 1:24). This will automatically synchronize the delay to the current tempo (MIDI, Internal, or TAP—see *Tempo Mode* in Chapter 2.) For example, a delay setting of 1:2 (1 echo for every 2 beats) will produce half-note delay rhythms synchronized to the current tempo.

Mstr Dly, Dly L, Dly R

These controls provide delay voices to the left and right channels. The delays are routed to the output (through the Lvl controls) and also through a feedback path. The master delay control allows you to simultaneously change the delay times of both voices. The available range is from 0-200%. This provides a simple way to expand or close in the voice delay times. If a voice's delay time is set to 500ms, changing the setting of Mstr Dly to 200% will change the delay time to 1.000sec. Setting this parameter to 0% is an easy way to set both delays to 0 from a single control.

When display of values in BPM has been selected, these are set as fractions of a beat. The smallest fraction is 1/24th beat. Delay times can also be tempo modulated.

Mstr Lvl, Lvl L, Lvl R

These controls modify the levels of the delay voices (Dly L and R) as they are routed to the output. The range of the left and right controls is from Full (0dB), to -85dB, to Off. Mstr Lvl provides grouped control from 0-100%. With low or moderate settings, small changes in Mstr Lvl may not have any effect.

Mstr Fbk L, Fbk R

These controls modify the levels of the delay feedback path. The range of the left and right controls is from -100% to +100% in 1% increments. Mstr Fbk provides grouped control from 0-100%. With low or moderate settings, small changes in Mstr Fbk may not have any effect.

Design The Design row, available in every algorithm, contains parameters that affect the structural aspects of the reverb effect. In the Chamber/Room algorithm, individual Design rows are available for Effect A and B.

Size

Size sets the rate of build-up of diffusion after the initial period (which is controlled by Diffusion). The Size control changes a reverb sound from very large to very small. Generally, you should set this control to approximate the size of the acoustic space you are trying to create, before adjusting anything else. The size in meters is roughly equal to the longest dimension of the space. Audio is temporarily muted when Size is changed.

Diffusion

A Diffusion control is provided in all algorithms. It controls the degree to which initial echo density increases over time. High settings of Diffusion result in initial build-up of echo density, and low settings cause low initial build-up. Echo density is also affected by Size; smaller spaces will sound denser. To enhance percussion, use high settings of Diffusion. For clearer and more natural vocals, mixes, and piano music, use low or moderate settings of Diffusion. Note that, at some extreme input levels, high settings of Diffusion may trigger the overload indicators on the headroom display.

Attack

Attack is provided in the Plate algorithm to set the sharpness of the initial response to an input signal. High settings cause an explosive sound, while low settings cause the sound to build up more slowly with time. Attack only affects the level of sound within the first 50 milliseconds.

Shape, Spread

In Random Hall, Concert Hall and Chamber/Room, Shape and Spread work together to control the overall ambience of the reverberation. Shape determines the contour of the reverberation envelope. With Shape all the way down, reverberation builds explosively, and decays quickly. As Shape is advanced, reverberation builds up more slowly and sustains for the time set by Spread. With Shape in the middle, the build-up and sustain of the reverberation envelope emulates a large concert hall (assuming that Spread is at least halfway up, and that Size is 30 meters or larger). Low Spread settings result in a rapid onset of reverberation at the beginning of the envelope, with little or no sustain. Higher settings spread out both the buildup and sustain.

Def

In the Concert Hall algorithm, Definition affects the echo density buildup rate during the latter part of the decay period. When set to Off, the rate is determined by the program material. Raising Definition through its range (1-99%) causes the sound to become choppy — the decrease in echo density creates increasingly distinct, repetitive echo trails.

Depth

In the Concert Hall algorithm, Depth sets the output amplitude envelope, changing the listener's perspective from the front to the rear of the hall.

Spin

Spin affects the movement of the reverberation tail. The object of Spin is to continuously alter the timbre of the reverberant sound. This makes the result more natural, without making the position of instruments unstable. Spin should typically be set to values between 10% and 50%. Higher values may make the timbre of piano or guitar unstable.

Chorus

In the Concert Hall algorithm, Chorus randomizes delay times and introduces modulation to make reverberation sound less metallic. Increasing Chorus increases the rate of modulation. Because Chorusing can cause pitch variation, this parameter should be set with care when using sources with very little pitch wobble (such as guitar or piano). A good practice is to increase the setting until pitch wobble becomes noticeable, then lower it slightly.

Link

This control is available in all algorithms except Ambience. When Link is set to On, the reverb time (Mid Rt) and Spread scale linearly as the Size control is varied. For some special effects, Mid Rt, Spread and Size can be unlinked.

High Cut

High Cut sets the high frequency cutoff of a low-pass filter. This parameter affects both channels.

Design cont'd. Range and Rate

Range and Rate controls in the Room algorithm in Chamber/Room can be used to reduce coloration for small room sizes or to reduce the sense of periodicity when the Infinite control is on. These controls allow you to set the range of a moving delay and the speed at which it moves. High settings of either control may be unsuitable for sustained tones, like piano.

Wander

Wander sets the distance (in time) that early reflections will move. For best results with larger sizes, this control should be set to about 10ms.

Echo Mstr Dly, Dly L, Dly R

In Rich Plate and Chamber/Room, Dly L and Dly R provide echoes to the left and right channels. Unlike Delay and Reflect, which are isolated left and right delays, left and right echoes are blended in the diffusor. The echoes are routed both to the outputs and through a feedback path. Mstr Dly provides a simple grouped control that modifies the left and right values from 0-200%.

Mstr Fbk, Fbk L, Fbk R

Fbk L and Fbk R modify the levels of the echo feedback path. The range is from -100% to 0 to +100%. Mstr Fbk has a range of 0-100%. With low or moderate settings, small changes of Mstr Fbk may not have an effect.

Expand Row 5 of the Concert Hall algorithm contains expansion controls for a built-in compressor/expander. (See also *Compress* at the beginning of this section.)**Ratio**

Ratio controls the slope of the expander circuit.

Threshold

Threshold sets the threshold below which gain is reduced.

Gain

Gain sets the amount of negative gain.

The Modulation row, which is the same for every algorithm, contains the parameters for the PCM 90's internal modulation sources. Use the Patch row to assign these modulators to any PCM 90 effect parameter.

Modulation

Mod: LFO1 and Mod:LFO2

Four parameters are available: **Shape**, **P Width**, **Depth**, and **Rate**.

Shape allows you to select the wave shape which will be used when "LFO" is selected as a patch Source. The choices are:

- Sine
- Cosine
- Square
- Sawtooth
- Pulse
- Triangle
- Random (outputs a new value on each cycle of the LFO)

P Width determines the proportion of each pulse wave cycle for which the LFO is on (1-99%). For example, setting **P Width** to 50% means that the LFO is on for half of its cycle. The effect of this control will only be heard if you are using the Pulse shape.

Depth scales the output of the LFO from 0 to 100%. This control affects the output of the LFO only. It has no effect on the outputs of the individual waveforms.

Rate sets the speed (0-10Hz) at which the LFO cycles. It can be set in time values (such as 1.5Hz) or in tempo values (such as 3:2 cycles per beat). Simultaneously pressing **Up** and **Tempo** will toggle these two display options.

Note: The PCM 90 allows six LFO shapes (sine, cosine, sawtooth, triangle, square and pulse) or a random shape to be selected as patch sources, as well as the LFO itself. All of these are generated by a single LFO, and are controlled by the single **Rate** control. When "LFO1" is selected, for example, as a patch source, the output will be the **Shape** selected here. The amplitude of the LFO output is controlled by **Depth**. Both Shape and Depth are available as patch destinations and can be controlled externally. Shape, Pulse Width, Depth, and Rate are all available as patch destination parameters, and can be controlled externally. See *Patching* in Chapter 2.

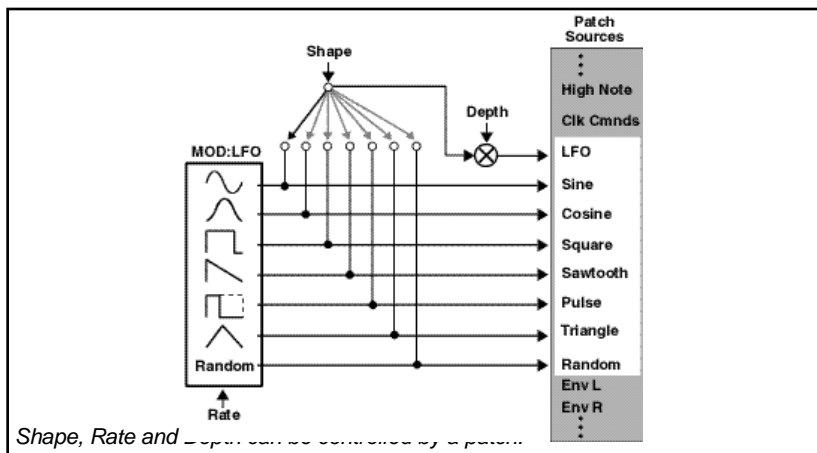

Modulation cont'd. Mod: AR Env

This envelope generator's output, when turned on, will go from 0 to 127. How quickly it goes from 0 to 127 is determined by the setting of **Attack** (0-10 seconds). Once the envelope generator has reached 127, it remains there as long as it is turned on. When it is turned off, it goes from 127 to 0, at the rate determined by **Release** (0 to 10 seconds).

T Src allows you to select a Source to turn the envelope generator on and off.

T Lvl allows you to select a specific threshold value which the **T Src** must reach to turn the envelope generator on.

The **Mode** parameter allows you to determine the behavior of the envelope controller in relation to the threshold value. Four settings are available: **Off, One Shot, Retrigger** and **Repeat**.

- Off** This control turns the AR envelope off (and frees up processor time). To optimize PCM 90 real-time response, set AR Env to **Off** when it is not being used.
- One Shot** Once **T Lvl** is reached, the envelope will go through its entire attack cycle. Once the attack cycle is completed, if Source value is *below T Lvl*, the envelope will immediately fall at the specified **Release** rate. The envelope will go through its entire release cycle, even if the source subsequently rises above **T Lvl**. If the Source value is *at or above T Lvl*, the envelope will remain at 127 until the **T Src** falls.
- Retrigger** As long as the level is at or above **T Lvl**, the envelope will go through its attack cycle. If the level falls below **T Lvl** before attack is completed, the envelope immediately begins to release. Likewise, if the **T Lvl** is crossed again before the release is completed, the attack cycle will begin again.
- Repeat** As long as the threshold source remains at or above **T Lvl**, the envelope cycles from attack to release. If A=R, the output of the envelope is a triangle wave.

Mod: Follow

This control provides three input signal envelope followers. Press **Load/★** to select Env L, Env R or Env L+R. The only available parameter is **Release** which is set in milliseconds. This control allows you to specify the release rate (0-10 seconds) when the input level drops.

Mod: Latch

The latch is a very flexible modulation source. It can be used to do such things as derive a switch from a continuous “return to zero” source (like MIDI After Touch). It can turn a momentary (on/off) footswitch into a latching footswitch (push on/ push off), and it can divide the switching rates of sources in half or thirds.

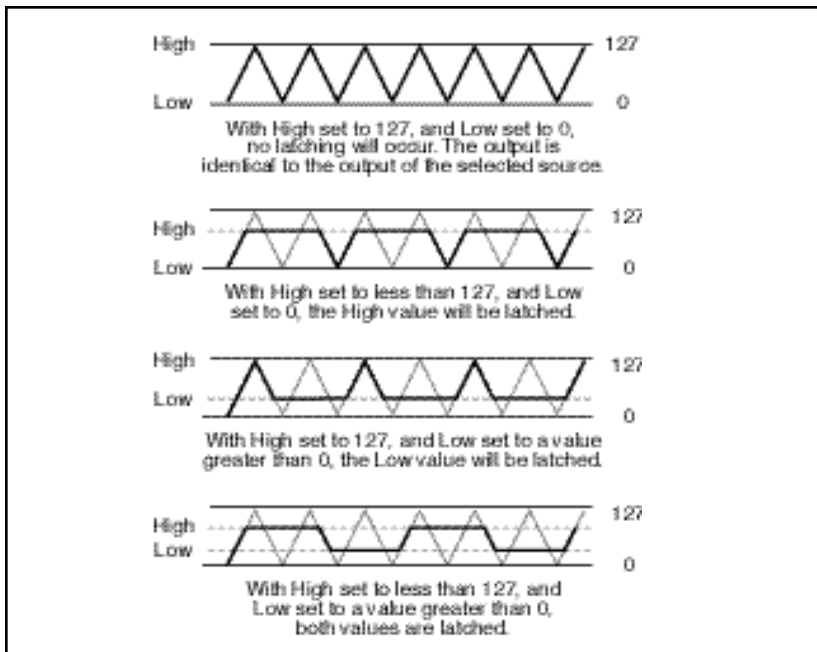
Modulation cont'd.

The latch has three parameters: **Src**, **High** and **Low**. Any patch source can be the **Src** (See Source listing under Patching.) **High** and **Low** are threshold values. The latch works as follows:

There is no output from the latch until the **Src** value falls within the range defined by the settings of **High** and **Low**. While the source value is between these thresholds, the output of the latch is the same value as the source. When the source value reaches or passes either threshold, the output of the latch holds at the limit value until the source value passes through the threshold twice. The latch can be set to hold at either the low threshold, the high threshold, or both. Setting **Low** to 0 disables latching at the low threshold. Setting **High** to 127 disables latching at the high threshold.

Modulation cont'd. Mod: Sw 1 and Mod: Sw 2

These are identical time switches. Each has five parameters: **Rate**, **P Width**, **Mode**, **T Lvl** and **T Src**.

Rate sets the speed (0-10Hz) at which the switch cycles. It can be set in time values (such as 1.5 Hz) or tempo values (such as 3:2 Cycles per Beat). Simultaneously pressing **Up** and **Tempo** will toggle these display options.

P Width determines the proportion of each cycle during which the switch is on. For example, setting **P Width** to 50% means that the switch is on for one-half of a cycle.

Mode determines the “shape” of the switch output. Three settings are available: **Off**, **Switch**, and **Ramp**. **Off** turns the switch off (and frees up processor time). To optimize real time response, set switch to **Off** when it is not being used. When **Switch** is selected, the transition from on to off is instantaneous, i.e. the switch output resembles a pulse wave. When **Ramp** is selected, the transition from on to off is continuous, i.e. the switch output resembles a triangle or sawtooth wave.

T Lvl sets the threshold value at which the switch will begin to cycle.

T Src selects a patch source to drive the switch. The output of the switch is 0 as long as **T Src** is set to a value below **T Lvl**. Once the source value reaches or passes **T Lvl**, the switch will begin to cycle between on (127) and off (0) at the speed set by **Rate**.

Note that both Rate and P Width are available as patch Destinations, allowing them to be dynamically controlled by other patch sources. Switches are reset to the beginning of their cycles whenever **Tap** is pressed.

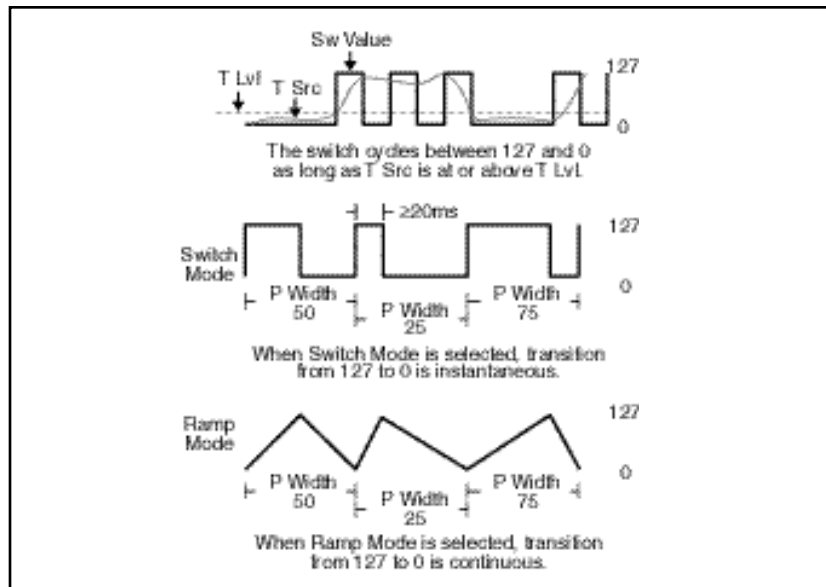

A special, composite output of these switches, called **Sw 1&2** is available as a patch source. The value of **Sw 1&2** alternates between the output of Sw 1 and the output of Sw 2. The alternation occurs on the transition from on to off. Note that both Sw 1 and Sw 2 must be active for the alternation to occur.

Modulation cont'd.

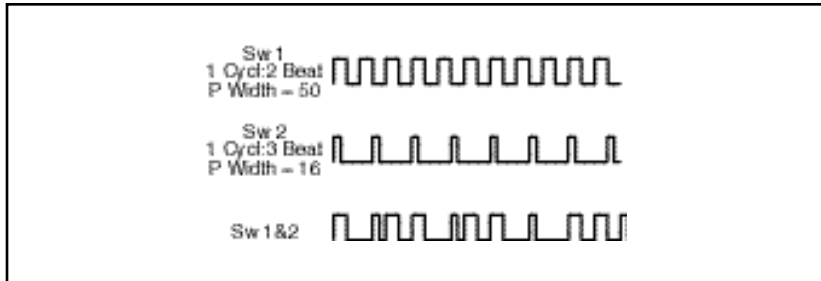

Mod: Delay

This control allows a copy of the output of any other patch source to be delayed. The delay time can be set as an absolute amount of time (0-5 seconds) or it can be related to tempo. The delayed value specified here can then be selected as a patch source.

Mod: S&Hold

The Sample & Hold control allows you to select an input source, a trigger for sampling the source, and a trigger threshold. Anything on the Patch Source list (shown on the following page) can be selected as an input source (**Src**). The trigger (**Trigger**) can be any other Patch Source. Each time the trigger rises above the threshold specified for **T Lvl**, the PCM 90 snaps a sample of the source and holds its value until the trigger once again exceeds the threshold. In example shown below, a sine wave is the source and Mono Lvl is the trigger. The threshold has been set at 90. Each time Mono Lvl rises above 90, the sine wave is sampled and held.

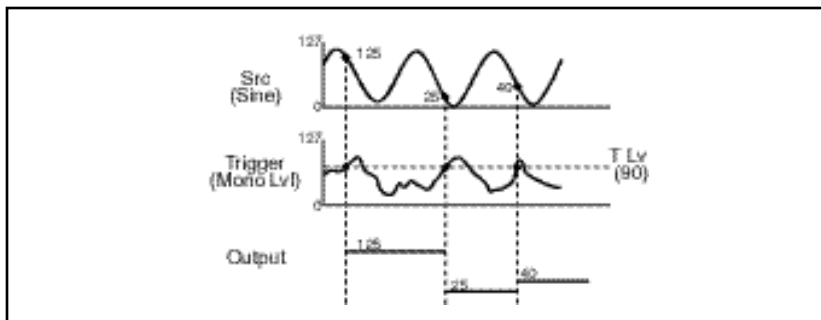

Patches

PCM 90 Patch Sources			
Internal		MIDI Controller Numbers	
LFO1	Latch	000	Ignored
Sine1	Sw 1	001	Mod Wheel
Cosine1	Sw 2	002	Breath
Square1	Sw 1 & 2	003	Ctl 3
Sawtooth1	Delay	004	Foot Ctl
Pulse1	S&Hold	005	PortaTime
Triangle1	Mono Lvl	006	Data Entry
Random1	Left Lvl	007	Volume
LFO2	Right Lvl	008	Balance
Sine2	FootPedal	009	Ctl 9
Cosine2	Foot Sw 1	010	Pan
Square2	Foot Sw 2	011	Xpression
Sawtooth2	ADJUST	012	Effect 1
Pulse2	Custom 1	013	Effect 2
Triangle2	Custom 2	014	Ctl 14
Random2	Custom 3	015	Ctl 15
Env L	Custom 4	016	General 1
Env R	Tempo	017	General 2
Env L+R	On	018	General 3
AR Env	Off	019	General 4
		020	Ctl 20
	
		031	Ctl 31
		(PCM 90 interprets 032 as Bank Select)	
		033	Ctl 33
	
		063	Ctl 63
		064	Sustain
		065	Porta On
		066	Sostenuto
		067	SoftPedal
		068	Legato
		069	Hold 2
		070	Sound Var
		071	Timbre
		072	Release
		073	Attack
		074	Bright
		075	Sound 6
		076	Sound 7
		077	Sound 8
		078	Sound 9
		079	Sound 10
		080	General 5
		081	General 6
		082	General 7
		083	General 8
		084	Porta Ctl
		085	Ctl 85
	
		090	Ctl 90
		091	FX1 Depth
		092	FX2 Depth
		093	FX3 Depth
		094	FX4 Depth
		095	FX5 Depth
		096	Data Inc
		097	Data Dec
		098	NRPN LSB
		099	NRPN MSB
		100	RPN LSB
		101	RPN MSB
		102	Ctl 102
	
		119	Ctl 119
MIDI			
P Bend			
A Touch			
Velocity			
Last Note			
Low Note			
High Note			
Clk Cmnds			

Following the Modulation row in each algorithm's edit matrix is the Patch row. This row provides parameters for creating as many as ten patches in each effect. Each row position (Patch 0-9) has three controls available: **Src**, **Dst**, and **Values**. Press **Load/★** to cycle among these selections.

Src

Use ADJUST to select any of the sources listed.

Dst

Use ADJUST to select any effect parameter except those on the Patch row.

Values

Use ADJUST to assign Destination values to specific Source values. These assignments are made in pairs, each with a value for the Source and a value for the Destination. For example, the default is two pairs mapped as follows:

minimum Source value (0) = minimum Destination value

maximum Source value (127) = maximum Destination value

This gives you a linear relationship between the parameter and the controller. Inverse control is accomplished easily by reversing these settings. As many as eight pairs of Destination/ Source values can be assigned here, providing an exciting new level of dynamic control.

See Chapter 2 for a complete description of the Patching System.

Mstr Dly, Dly L, Dly R

Dly L and Dly R provide pre-echoes to the left and right channels. Mstr Dly provides a simple grouped control that modifies the left and right values from 0-200%.

Mstr Lvl, Lvl L, Lvl R

In Random Hall, Concert Hall and Rich Plate, Lvl L and Lvl R modify the levels of the reflections (Dly L and R). The range of each is from Full (0dB) to -85dB, to Off. Mstr Lvl has a range of 0-100%.

Reflect

Spatial EQ, when used to enhance the spaciousness of stereo material, increases low frequency differences between left and right channels. An effect called "negative cross-feed" is created by subtracting a copy of low frequency on the left from the right channel, and vice-versa. This effect can be dramatic when used judiciously on live stereo recordings.

Spatial EQ

Spatial EQ can also be used to reduce low frequency differences and steer the bass into mono. This might be used in mastering LPs to keep the stylus in the groove, in TV mixing, or in any situation in which the low frequency load should be shared by both speakers. Spatial EQ used in this manner is said to have "positive cross-feed".

In the PCM 90, Spatial EQ is placed in the signal path where it can process the dry signal, the reverberation, or both.

Premix

In Concert Hall, Spatial EQ is placed in the signal path after the reverberator. An additional dry signal is also provided so that the dry input can be sent to the Spatial EQ. In this case, we recommend setting the value of Mix in the Controls row to 100% so that Premix controls the wet/dry mix.

Crossover

Crossover sets the frequency below which the Spatial EQ effect takes place. Setting this frequency too high may result in unusual imaging.

Gain

Gain sets the amount of crossfeed between channels. The signal first goes through a 6 dB/octave low-pass filter whose frequency is set with Crossover. When Gain is set positive (above 0) the crossfeed has a negative sign. This *increases* the sense of spaciousness. When Gain is set negative (below 0), the crossfeed has a positive sign. This *reduces* the sense of spaciousness. When the control is set to either maximum or minimum, the gain in the crossfeed circuit is unity. At maximum, low frequency mono signals are completely removed. This represents an extreme setting which should seldom be needed in practice.

Raising Gain may reduce the bass level. This effect can be compensated for by raising the overall bass level with BassBoost. Since both controls use the same Crossover setting, this compensation will be quite accurate as long as Gain is set to less than 3 dB boost. With Gain at its lowest setting, low frequency signals are completely mono. This may increase the bass level, which can then be cut by lowering the BassBoost control.

BassBoost

A positive value for Gain may reduce low frequencies in program material. Conversely, a negative value for Gain may increase low frequencies. BassBoost allows compensation for this effect by boosting or cutting frequencies below Crossover. The amount of boost or cut required is highly dependent on the material being processed. Start by setting this control to the same value as the Gain control, and then adjust it as necessary.

Time The Time row, available in every algorithm, contains parameters that affect the time-based aspects of the reverb effect.

Mid Rt and Low Rt

Mid Rt sets the reverb time for mid-frequency signals. Because low frequency reverb time (Low Rt) is a multiplier of Mid Rt, Mid Rt acts as a master control for the reverb time.

Low Rt sets the reverb time for low-frequency signals, as a multiplier of the Mid Rt parameter. For example, if Low Rt is set to 2X, and Mid Rt is set to two seconds, the low frequency reverb time will be four seconds. For a natural-sounding hall ambience, we recommend values of 1.5X or less.

Crossover

Crossover sets the frequency at which the transition from Mid Rt to Low Rt takes place. This control should be set at least two octaves higher than the low frequency you want to boost. For example, to boost a signal at 100Hz, set Crossover to 400Hz. (This setting works well for classical music.) Crossover works best around 400Hz for boosting low frequencies, and around 1.5 kHz for cutting low frequencies.

Rt HC

Rt HC sets the frequency above which a 6dB/octave low-pass filter attenuates the reverberated signal. It does not attenuate the reflections. High frequencies are often rolled off with this parameter, resulting in more natural-sounding reverberation. Setting a low frequency for this parameter can actually shorten the reverb time, as it damps the audio as it recirculates.

Pre Delay

Pre Delay adjusts an additional time delay between the input of signal and the onset of reverberation. The maximum range is 1000ms. This control is not intended to mimic the time delays in natural spaces. In real rooms, the build-up of reverberation is gradual, and the initial time gap is usually relatively short. Natural spaces are best emulated by adjusting Spread for the desired effective pre-delay. This parameter is available for tempo control in all algorithms except Ambience.

Shelf

In Random Hall, Shelf modifies the lowpass characteristic of Rt HC, turning it into a shelving filter. Shelf sets the gain of an output patch which is mixed with the output of Rt HC to form the main reverberant output. Both the pre-echoes and the reverberation are affected. For example, if Shelf is set to -6dB, frequencies below approximately Rt HC/2 will be boosted by 3.5dB. Above approximately Rt HC/2, the response will be flat.

Shelf provides a method for making the spectral content of the reverberation match the ideal spectrum for musical acoustics in rooms. For this application, Rt HC should be set between 700 and 1.5kHz, with Shelf set between -12 and -6dB.

Decay

In Ambience, Decay controls the length of the ambience "tail".

Decay Lvl

In Ambience, Decay Lvl controls the level of the ambience "tail". When Decay Lvl is off, ambience consists entirely of the early reflection signal.

Dry Dly

Dry Dly is used to add fine control to Ambience. An additional dry path is created "inside" the ambience effect. When necessary, this path can be delayed slightly to match an ambience.

DryDlyMix

In Ambience, DryDlyMix is used to control the relative levels of the internal dry path and the ambience effect itself. A value of 100% indicates a completely dry path. This is identical to the normal external dry path, except that it is delayed by DryDly. If this control is used to vary the wet/dry mix, it is recommended that the value of Mix on the Controls row be set to 100%.

Infinite

In the Room algorithm, this control is provided to turn the Infinite effect On or Off.

The Presets

The PCM 90 has 250 factory-designed presets which are organized into five banks of 50 each (labeled **P0**, **P1**, **P2**, **P3** and **P4**). Each bank is organized in a matrix of 5 rows of 10. Press the front panel **Program Banks** button to display the first bank. Press it again to switch to another bank. Simultaneously press **Program Banks** and either the **Up** or **Down** button to backstep through the banks. The display will show the bank label and the matrix location, the preset name, and the algorithm from which the effect is derived.

Turn **SELECT** to scroll through all of the presets in a bank in numerical order. Use **Up** or **Down** to jump forward or backward by 10. Press **Load/★** to load any displayed preset.

In the Program Banks mode (as in the Register Banks mode), **ADJUST** is a soft knob. Each preset has one or more parameters patched to this knob, providing a quick way to make useful changes to the effect. When you turn **ADJUST**, the display will show the name assigned to **ADJUST**, as well as the patch value. Continue turning **ADJUST** to alter the patch value along its available range. Many of the presets also have Custom Controls assigned to provide easy access to even more parameters. Look for these in the Soft row.

The program banks are organized as follows:

Bank P0 Halls 0.0-0.9 Orchestral 1.0-1.9 Vocal 2.0-2.9 Live Sound 3.0-3.9 Instrument 4.0-4.9 Custom	Bank P1 Rooms 0.0-0.9 Instrument 1.0-1.9 Vocal 2.0-2.9 Live Sound 3.0-3.9 Drums&Perc 4.0-4.9 Custom	Bank P2 Plates 0.0-0.9 Instrument 1.0-1.9 Vocal 2.0-2.9 Live Sound 3.0-3.9 Drums&Perc 4.0-4.9 Custom	Bank P3 Post 0.0-0.9 Indoor Small 1.0-1.9 Indoor Large 2.0-2.9 Outdoor 3.0-3.9 Spatial 4.0-4.9 Custom	Bank P4 Splits 0.0-0.9 Mono 1.0-1.9 Stereo 2.0-2.9 Live Sound 3.0-3.9 Instrument 4.0-4.9 Custom
---	---	--	---	---

Each preset is described in this section with a header which indicates the matrix location, the program name, the name assigned to the **ADJUST** knob, as well as any **KeyWords** assigned for sorting. This header is followed by a brief description of the effect and a list of any Custom Controls assigned.

Program Bank P0 Halls

Orchestral

0.0 Deep Blue ADJUST: Decay

Keywords: Large, Tempo, RandomHall

This is an all-purpose hall with moderate size and delay time. The reflection delays are set at 36 and 34 ms, but the master level is off. Set to desired level for initial reflections. The master delays are set to beat 3 against 2, but their levels are also off. Set the master delay level to hear the delays. You can also set the tempo of these delays with **Tap**. Custom 1 allows control of the source from stereo to a narrow setting just a bit wider than mono.

0.1 Large Hall ADJUST: Decay

Keywords: Large, Long, RandomHall

A classic reverb preset. The hall size is large, with a gentle bloom in the reverberation envelope. The first set of pre-echoes are set to 14 and 20 ms, but are turned off in the preset. Use ADJUST to add some initial reflections.

0.2 Medium Hall ADJUST: Decay

Keywords: Medium, Indoor, RandomHall, Orchestral

A natural sounding hall, with moderate decay time. Similar to Large Hall, but a smaller room with proportionately shorter decay time.

0.3 Small Hall ADJUST: Predelay

Keywords: Small, RandomHall, Orchestral, Short

A natural sounding environment with bright initial reverb that decays quickly. Turn ADJUST up for a small early reflection or down for a more diffused decay.

Presets 0.4-0.6 are similar in texture to the first 3 presets in this row, with added reflections from a stage. In each, ADJUST is designed to allow you to change the size of the stage.

0.4 L Hall+Stage ADJUST: Stage Size

Keywords: Large, RandomHall, Long, Orchestral

0.5 M Hall+Stage ADJUST: Stage Size

Keywords: Medium, RandomHall, Orchestral, Indoor

0.6 S Hall+Stage ADJUST: Stage Size

Keywords: Small, Short, RandomHall, Orchestral

0.7 Gothic Hall ADJUST: Decay

Keywords: Large, Long, RandomHall, Orchestral

A large, spacious and filtered medium-bright reverb, as in a space made of stone. Smaller room sizes add density to the sound.

0.8 Concert Hall ADJUST: Decay

Keywords: Large, Instrument, Cncrt Hall, Orchestral

A large, smooth, dark and lush concert hall. Very dense with reflections added to reinforce the sound. Classic Lexicon!

0.9 Small Church ADJUST: Decay

Keywords: Small, Film-ADR, RandomHall, Orchestral

A smaller version of Large Church with no reflections and much shorter decay time.

Vocal

P0 Halls cont'd.

- 1.0 Choir Hall** **ADJUST: Decay**
Keywords: Large, Short, RandomHall, Vocal
 A medium sized space with lots of reflections. Fairly dark timbre and a bit of predelay make it more suitable for a group of voices rather than a soloist.
- 1.1 Vocal Hall** **ADJUST: Liveness**
Keywords: Medium, Natural, RandomHall, Vocal
 This medium-sized hall has a short, clear reverb decay that doesn't get in the way of the source. Great for vocals or any other instrument with a very defined pitch, such as piano. ADJUST varies the room's tonal characteristics.
- 1.2 Vocal Hall2** **ADJUST: Liveness**
Keywords: Short, Natural, RandomHall, Vocal
 This is a fairly large hall with a generous reverb decay. A flat high cut keeps the tail from muddying the source. ADJUST varies the room's tonal characteristics.
- 1.3 VocalConcert** **ADJUST: Seating**
Keywords: Short, Large, Concert Hall, Vocal
 An enormous slightly reflective room. When ADJUST is low, the source is clear and close. Increasing ADJUST creates a longer decay and makes the source more diffuse and the higher frequencies roll off. This creates the illusion of moving the listener's vantage point further back, away from the stage.
- 1.4 Rise'n Hall** **ADJUST: Decay**
Keywords: Vocal, Medium, RandomHall, Long
 A strange hall with a long early reflection rise and a short decay, creating an echo verb effect on leads.
- 1.5 Good Ol' Verb** **ADJUST: Attitude**
Keywords: Large, Natural, RandomHall, Vocal
 A quick solution when you're looking for a well rounded reverb. ADJUST is patched to stereo width, predelay, and the reverb's high cut parameter, giving you extensive control over the sound of the effect.
- 1.6 Deep Verb** **ADJUST: Decay**
Keywords: Large, Short, RandomHall, Vocal
 A large, washy, chorused space.
- 1.7 Vocal Magic** **ADJUST: Decay**
Keywords: Cncrt Hall, Vocal, Large, Long
 A lovely reverb with a short decay that is perfect as a vocal reverb.
- 1.8 Wide Vox** **ADJUST: Width Arc**
Keywords: Medium, Unnatural, RandomHall, Vocal
 This preset doubles the source with close delays and widens the stereo signal. ADJUST controls width, the delay feedbacks, Shelf, and Mid reverb time to alter the apparent width of the source on the sound stage.
- 1.9 Slap Hall** **ADJUST: Decay**
Keywords: Cncrt Hall, Vocal, Dark, Slap FX
 Provides a dense reverb with a soft initial double tap of the source, before darkening and decaying.

P0 Halls cont'd.**Live Sound**

- 2.0 Live Arena** **ADJUST: Seating**
Keywords: RandomHall, Live PA, Large, Long
 A very large hall with moderate reverb decay time. ADJUST allows you control the apparent distance from the sound source. Best suited for non-percussive sources.
- 2.1 Real Hall** **ADJUST: Decay**
Keywords: Cncrt Hall, Live PA, Dark, Medium
 A small, relatively bright sounding hall, good for all program material.
- 2.2 Great Hall** **ADJUST: Decay**
Keywords: Cncrt Hall, Live PA, Long, Bright
 A great hall reverb that works well with all program material.
- 2.3 Brick Wallz** **ADJUST: Decay**
Keywords: RandomHall, Live PA, Unnatural, Dark,
 A wide and abrupt sounding, gated effect.
- 2.4 Cannon Gate** **ADJUST: Decay**
Keywords: Ambience, Live PA, Gated, Short
 This medium-sized room has a sharp, medium long decay. Great on percussive and lead sounds.
- 2.5 Spatial Hall** **ADJUST: Decay**
Keywords: Cncrt Hall, Live PA, Spatial, Surround,
 A strange hall with an LFO controlling spatial EQ. The reverb tail moves in and out of the stereo field.
- 2.6 Nonlin Wrhse** **ADJUST: Decay Level**
Keywords: Ambience, Live PA, Gated, Unnatural
 A large nonlinear reverb that sounds like a gated warehouse.
- 2.7 Sizzle Hall** **ADJUST: Decay**
Keywords: RandomHall, Live PA, Medium, Bright
 A bright, close hall with medium short decay with a very live reverb quality.
- 2.8 Bright Hall** **ADJUST: Tail Brightness**
Keywords: Medium, Bright, RandomHall, Live PA
 A light reverb with a great deal of high end activity. A short decay time keeps the reverb tail from muddying the effect. This hall was designed to provide a lush, bright reverb ideal for cutting through the darkness in live settings.
- 2.9 Utility Hall** **ADJUST: Decay**
Keywords: RandomHall, Live PA, Dark, Medium
 A truly useful large hall with very little high frequency content. Adds spaciousness to all sounds without getting in the way.

Instrument

P0 Halls cont'd.

- 3.0 Horns Hall** **ADJUST: Timbre**
Keywords: Cncrt Hall, Instrument, Natural, Acoustic
 A very large space, ideal for horns. ADJUST optimizes the timbre of the horn for a bright, or warm sound.
- 3.1 Snare Gate** **ADJUST: Release & Threshold**
Keywords: Cncrt Hall, Instrument, Gated, Drums/Perc
 A very tight, gated hall reverb. Roomy and dense when open but slams shut abruptly. Perfect for snare drums and other percussive instruments.
- 3.2 Guitar Cave** **ADJUST: Decay**
Keywords: Instrument, RandomHall, Guitar, Dark
 Long predelay with recirculating echoes. The main delay taps give it a lot of left and right bouncing activity. Great solo preset.
- 3.3 Drum Cave** **ADJUST: Decay**
Keywords: Drums/Perc, Small, RandomHall, Instrument
 A medium sized cave with short decay time. Use ADJUST to vary reverb decay time to suit the tempo of the music.
- 3.4 Saxy Hangar** **ADJUST: Out Width**
Keywords: Ambience, Instrument, Long, Acoustic
 A large hall that sounds like an airplane hangar designed for a spacious sax solo.
- 3.5 Gated Hall** **ADJUST: Room Size**
Keywords: Instrument, Large, RandomHall, Gated
 If it were possible to have a gated hall, it would sound like this.
- 3.6 For The Toms** **ADJUST: Room Type**
Keywords: Ambience, Instrument, Short, Drums/Perc
 A large, dense room reverb for toms and other percussives.
- 3.7 Synth Hall** **ADJUST: Decay**
Keywords: Cncrt Hall, Instrument, Keyboard, Long
 A chorused hall with long decay time for all synth type pads and washes. Also good on strings. Pitched sound sources may seem to sway from center pitch. This can be made more or less dramatic dependent upon the chorus value.
- 3.8 ShortReverse** **ADJUST: Shape**
Keywords: Cncrt Hall, Instrument, Special FX, Unnatural
 A short reverse reverb with a quick build up and short decay. Good for leads and percussives.
- 3.9 GtrBalladBPM** **ADJUST: High Cut**
Keywords: Instrument, RandomHall, Tempo, Ballad
 This medium-sized room blends a 2-second reverb decay with delay taps that beat according to the tempo you **Tap** in.

P0 Halls cont'd.**Custom**

- 4.0 Tidal Hall** **ADJUST: LFO1 Rate**
Keywords: Cncrt Hall, Custom, Dynamic, Unnatural
 A strange hall with an LFO controlling the high cut of the reverb as well as the output width, creating an "in and out" kind of washing action on the verb.
Custom 1: Wash Density
Custom 2: Liveness
Custom 3: Reverb Density
Custom 4: Yank the Inputs
- 4.1 Dream Hall** **ADJUST: LFO1 & LFO2 Rates**
Keywords: RandomHall, Custom, Bright, Slap FX
 A bright, crystalline hall with potent but subtle delay taps that pan randomly from left to right, then fade. ADJUST controls the pan rate.
Custom 1: Dream Taps
Custom 2: Reverb Density
Custom 3: Shape & Spread
- 4.2 PumpVerb** **ADJUST: Decay**
Keywords: Cncrt Hall, Custom, Large, Long
 A strange, semi-gated reverb with pumping from the compressor, which is following the input signal. Sounds cool on drums and percussives.
Custom 1: Expander Gate
Custom 2: Reverb Density
Custom 3: Spatial Bass EQ
Custom 4: Liveness
- 4.3 PanHallBPM** **ADJUST: Tap Rate**
Keywords: RandomHall, Custom, Spatial, Tempo
 This unique hall patches LFO1 to OutWidth, creating a subtle sweeping sensation. The sweep rate is dependent upon either tempo set through **Tap** or **ADJUST**.
Custom 1: Spiral Depth
Custom 2: Reverb Density
Custom 3: Liveness
Custom 4: Brightness
- 4.4 Utility Verb** **ADJUST: Out Width**
Keywords: Unnatural, Gated, Concert Hall, Custom
 A general, all purpose reverb with medium parameter settings.
Custom 1: Effect Gate Release
Custom 2: Liveness
Custom 3: Width/EQ
Custom 4: Wah-Wah Speed
- 4.5 Museum Hall** **ADJUST: Reflective Material**
Keywords: Cncrt Hall, Custom, Indoor, Bright
 A large reverberant hall like a large room in a museum. ADJUST selects the physical characteristics of the walls.
Custom 1: Source Proximity
Custom 2: Width EQ
Custom 3: Reverb Tail
Custom 4: Room Size

4.6 Nonlinear#1 **ADJUST: Room Size** **P0 Halls cont'd.****Keywords: Ambience, Custom, Gated, Short,**

A dense, medium long, nonlinear gated verb. Good for all sorts of program material, especially percussive sounds.

Custom 1: Tail Environment**Custom 2: High Cut****Custom 3: Decay****Custom 4: Decay Level****4.7 Tap BrickBPM** **ADJUST: Tap Rate****Keywords: RandomHall, Custom, Tempo, Spatial**This preset has a very reflective sound, as if the source is pounding against a hard brick wall. The LFO opens up the Mid RT and controls OutWidth in cycles that are tempo dependent. Use **Tap** or **ADJUST** to control the rate.**Custom 1: Liveness****Custom 2: Size****Custom 3: Tap Depth****Custom 4: Outwidth Tap Sweep****4.8 Gen. Concert** **ADJUST: not patched****KeyWords: Cncrt Hall**

A generic concert hall. Use this as a starting place to make your own concert hall effects.

4.9 Gen. RHall **ADJUST: not patched****KeyWords: RandomHall**

A generic hall with random reflections. Use this as a starting place to make your own random hall effects.

Instrument**Program Bank P1
Rooms****0.0 Large Room** **ADJUST: Decay****Keywords: Large, Room, Instrument, RandomHall**

A perfectly smooth listening room with high diffusion. Very natural sounding on any sound source.

0.1 Medium Room **ADJUST: Decay****Keywords: Medium, Room, Instrument, RandomHall**

A smaller version of the Large Room preset.

0.2 Small Room **ADJUST: Decay****Keywords: Small, Room, Instrument, RandomHall**Use **ADJUST** to quickly change the reverb decay time on this typically tight sounding room. Like its two larger counterparts, Small Room is smooth and natural sounding.**0.3 Guitar Room** **ADJUST: High Cut****Keywords: Guitar, Room, Instrument, Ambience**A tight and punchy ambience effect, combining the smallest of sizes and reverb times. Use the **ADJUST** knob to roll off the higher frequencies.**0.4 Organ Room** **ADJUST: Low Rt****Keywords: Keyboard, Room, Splits, Instrument**

This Chamber/Room effect is ideally suited for organ and other keyboards with its medium size, natural reverb, and a bit of predelay.

- P1 Rooms cont'd.**
- 0.5 LargeChamber** **ADJUST: Decay**
Keywords: Large, Chamber, RandomHall, Instrument
A smooth, large reverberant space using Shape and Spread to add some definition.
- 0.6 SmallChamber** **ADJUST: Decay**
Keywords: Small, Chamber, RandomHall, Instrument
Just like its bigger predecessor, but with a tighter Mid Rt and a smaller size.
- 0.7 SpinningRoom** **ADJUST: Speed**
Keywords: Room, Instrument, Spatial, Ambience
A nice Ambience reverb with a circular sweep of Out Width. Great as a special effect or for adding some movement to your mix. ADJUST controls the rate of the circular sweep.
- 0.8 Wide Chamber** **ADJUST: Decay**
Keywords: Chamber, Orchestral, Instrument, RandomHall
A big and wide sounding space with a preset medium Mid Rt. A dark, somber reverb.
- 0.9 Tiled Room** **ADJUST: Rt HC**
Keywords: Room, Bright, Instrument, Cncrt Hall
Just what you'd expect — an incredibly sibilant and bright reverberant space. Use ADJUST to soften the brightness of this short reverb.

Vocal

- 1.0 Brite Vocal** **ADJUST: High Cut**
Keywords: Bright, Room, Vocal, Ambience
This effect is ideal for vocalists using a bit of predelay to separate the bright reverb from the source for definition and clarity. ADJUST controls brightness.
- 1.1 Vocal Space** **ADJUST: Size**
Keywords: Room, Vocal, Small, RandomHall
A short Mid RT and small Size — an ideal space for vocals due to the use of Shape and Spread.
- 1.2 Vocal Amb** **ADJUST: Diffusion**
Keywords: Dark, Natural, Vocal, Ambience
Short and soft. A very realistic small room.
- 1.3 VerySmallAmb** **ADJUST: Width**
Keywords: Small, Vocal, Ambience, Ballad
Just like Vocal Amb, but smaller and tighter. ADJUST provides mono to stereo OutWidth control.
- 1.4 S VocalSpace** **ADJUST: High Cut**
Keywords: Vocal, Ambience, Small, Ballad
A small, smooth space, well-suited for vocals. A Decay Level of -8dB keeps the reverb from becoming overpowering.
- 1.5 L VocalSpace** **ADJUST: High Cut**
Keywords: Large, Vocal, Ambience, Ballad
A bigger version of S VocalSpace.
- 1.6 S Vocal Amb** **ADJUST: Diffusion**
Keywords: Small, Vocal, Ambience, Custom
Use Custom 1 to choose the right studio for your vocalist.
Custom 1: Choose the Studio

1.7 L Vocal Amb **ADJUST: Diffusion** **P1 Rooms cont'd.****Keywords: Large, Vocal, Ambience, Custom**

A more spacious version of S Vocal Amb. Already set to Studio "A". Customize your vocals with ADJUST and the three studio settings on Custom 1.

Custom 1: Choose the Studio**1.8 AmbientSus** **ADJUST: Size****Keywords: Ambience, Natural, Vocal**

A bit of dry delay makes this a sweet selection for your vocal tracks. You'll find the subtleties of this preset will perfectly suit instruments as well.

1.9 Vocal Booth **ADJUST: Walls/Size****Keywords: Vocal, Cncrt Hall, Small, Dialog**

The most confining of isolation booths. ADJUST lets you select wall materials and booth size.

Live Sound**2.0 LargeSpace** **ADJUST: Decay****Keywords: RandomHall, Live PA, Large, Bright**

Designed for live sound reinforcement in all situations.

2.1 Med. Space **ADJUST: Decay****Keywords: RandomHall, Live PA, Medium, Instrument**

For a more intimate and small setting, choose this preset with its smooth reverb and softer timbre.

2.2 Delay Space **ADJUST: Decay****Keywords: RandomHall, Live PA, Small, Tempo**

Attitude for live drums, guitar, or vocals with a less dominating reverb, punchier sound, and lots of delay. **Tap** in delay time, or dial in the BPM of the song.

2.3 BigBoom Room **ADJUST: Blend****Keywords: Split Rvb, Live PA, Custom, Large**

This preset is saturated with bottom-heavy, dense reverb. Configure the input as stereo or mono to get your sound sources to this dense room. Use ADJUST to blend between rooms and to adjust distance from the sound source.

Custom 1: Bass Boost**2.4 Tight Space** **ADJUST: Proximity****Keywords: Ambience, Live PA, Gated, Drums/Perc**

An effect to give your live drums that extra push. Vibrancy and attitude with a gated feel. Use ADJUST to add space and reverb, or to bring the effect up to the front with less reverb.

2.5 Reflect Room **ADJUST: Arena Size****Keywords: Concert Hall, Live PA, Large, Unnatural**

Super-saturated, atmospheric quality. Great for creating a dreamy landscape for the solo instrument or vocalist.

2.6 RockRoom **ADJUST: Liveness****Keywords: RandomHall, Live PA, Small, Drums/Perc**

A great preset for live drum sound. Extremely bright with no RT HC.

2.7 Real Room **ADJUST: Size****Keywords: Ambience, Live PA, Natural, Acoustic**

A bit more natural reverb for a live setting. Smooth and subtle, perfect for anything you throw at it.

- P1 Rooms cont'd.**
- 2.8 Spatial Bass** **ADJUST: High Cut**
Keywords: Cncrt Hall, Live PA, Short, Spatial
 A Spatial EQ bass boost enhances the lower frequencies of your sound source and combines it with a bright reverb on top.
- 2.9 Great Room** **ADJUST: Liveness**
Keywords: Cncrt Hall, Live PA, Instrument, Acoustic
 The same warm, smooth reverb as Real Room, with more decay time and an overall warmer timbre.

Drums&Perc

- 3.0 Drum Room** **ADJUST: Size**
Keywords: Ambience, Drums/Perc, Instrument, Short
 With the whole kit in mind, the staple for this dark drum preset is its dense, saturated reverb.
- 3.1 Snare Trash** **ADJUST: Rt HC**
Keywords: Cncrt Hall, Drums/Perc, Instrument, Medium
 The large room size, short Mid Rt, and cut of the Spatial EQ bass boost all play a significant role in the search for the perfect snare reverb.
- 3.2 MetallicRoom** **ADJUST: Decay Lvl**
Keywords: Ambience, Drums/Perc, Instrument, Small
 The resonant quality of this drum preset comes from its very small Size and Mid Rt settings. You'll find this preset works best on individual drums rather than the whole kit.
- 3.3 Slap Place** **ADJUST: Pre Delay**
Keywords: Ambience, Drums/Perc, Instrument, Medium
 A dark and wet reverb. Medium room size and long reverb tail make this a good choice for a big drum sound. For a bit of space before your reverb kicks in, dial in the Pre Delay you want with ADJUST.
- 3.4 PercussPlace** **ADJUST: Decay Lvl**
Keywords: Ambience, Drums/Perc, Instrument, Medium
 Congas, bongos, bells, and whistles are all at home with this preset. A full and resonant reverb accentuates the transients as well as the pitch material in percussive instruments.
- 3.5 PercussRoom** **ADJUST: Decay Lvl**
Keywords: Ambience, Drums/Perc, Instrument, Short
 Similar to PercussPlace with slightly smaller Mid Rt and Size settings for a more intimate effect.
- 3.6 Room 4 Drums** **ADJUST: Decay Lvl**
Keywords: Ambience, Drums/Perc, Instrument, Short
 All you could ever want for drums — punch, attitude, and a tight, beefy reverb. Crank it up!
- 3.7 Sloppy Place** **ADJUST: Sloppiness**
Keywords: Ambience, Drums, Dark, Unnatural
 An unnatural room reverb that will enhance any drum track.
- 3.8 WideSlapDrum** **ADJUST: Spatial Enhance**
Keywords: Cncrt Hall, Drums, Slap FX, Spatial
 Perfect as a special drum effect. ADJUST takes you from narrow and dry to wide and slap happy.

3.9 InverseDrums **ADJUST: Spread** **P1 Rooms cont'd.****Keywords: RandomHall, Drums, Special FX, Unnatural**

A backwards effect. Great as a special effect for one drum, or the whole kit. ADJUST lets you smooth out or tighten up the time it takes to get that perfect backwards sound.

Custom**4.0 PCM 60 Room** **ADJUST: Reverb Time****Keywords: Plate, Large, Custom, Natural**

Let this preset take you back to the good old days of 1984 when life was simple, and so were the reverbs. Use ADJUST to choose the color and reverb time that was your favorite, then use the Customs 1 and 2 to set Size and exercise that wonderful feeling of power with the Bass/Treble Contour control. Customs 3 & 4 offer effects you thought not possible in 1984 — backwards effects and adjustable echoes.

Custom 1: Size**Custom 2: Contour****Custom 3: Inverse Effects****Custom 4: Echoes****4.1 InverseRoom2** **ADJUST: Width****Keywords: RandomHall, Drums/Perc, Unnatural, Custom**

Lots of options via ADJUST and the Customs to create a great backwards effect.

Custom 1: High Cut**Custom 2: Reflections****Custom 3: Liveness****Custom 4: Input Pulse****4.2 BeeBeeSlapz** **ADJUST: Feedback****Keywords: Cncrt Hall, Slap FX, Unnatural, Custom**

Perfect for creating dreamy soundscapes, and atmospheric moods dripping with reverb. ADJUST takes you from dry delay taps to complete reverb abandon, Custom Controls set the atmosphere.

Custom 1: Comp/Ratio Thrshld**Custom 2: Spatial EQ****Custom 3: Moving Reflections****4.3 Storeroom** **ADJUST: Amount of Boxes****Keywords: Cncrt Hall, Dark, Indoor, Custom**

A storeroom where ADJUST lets you customize how empty or full it is, and hear how it affects the sound. Customs let you further define the space.

Custom 1: BassBoost**Custom 2: Delay Taps****Custom 3: Width****4.4 Split Rooms** **ADJUST: Reverb Balance****Keywords: Split Rvb, Special FX, Dynamic, Custom**

A Chamber/Room where both the small room and the big, bright chamber are patched with the AR Envelope to Mono InLvl. Below a certain point, only the Room reverb is heard. When the threshold is crossed, the Room drops out and the Chamber reverb kicks in. ADJUST lets you blend or separate the two rooms.

Custom 1: In Routing**Custom 2: Inverse HighPass****Custom 3: Reverb Density**

- P1 Rooms cont'd.**
- 4.5 Spatial Room** **ADJUST: Spatial Movement**
Keywords: Ambience, Spatial, Unnatural, Custom
 Similar to SpinningRoom, but with a different parameters, and more Custom Controls.
Custom 1: LFO Shape
Custom 2: HighPass
Custom 3: Gliding Chorus
Custom 4: Verb Proximity
- 4.6 Hole Room** **ADJUST: Decay**
Keywords: Cncrt Hall, Special FX, Custom, Unnatural
 A dense ConcertHall reverb. Customize your decay time with ADJUST, Bass Boost with Custom 1, Liveness with Custom 2, throw in some backwards effects with Custom 3, and control the Wet/Dry mix with Custom 4.
Custom 1: BassBoost
Custom 2: Liveness
Custom 3: Inverse Effects
Custom 4: Dry/Wet Mix
- 4.7 Storage Tank** **ADJUST: Fullness/Size**
Keywords: Ambience, Dark, Indoor, Custom
 A storage tank with a metallic sound and bright, resonant reverb. Change the Fullness and the Size of the tank with ADJUST, and the density of the Ambience with Custom 1. The AR Envelope is patched to OutWidth and triggered by the Mono InLvl. When the threshold is crossed, the effect changes from Mono to Stereo.
Custom 1: Amb Density
Custom 2: TriggerRelease Width
- 4.8 StrangePlace** **ADJUST: Chorus**
Keywords: Cncrt Hall, Spatial, Custom, Unnatural
 A super-tight ConcertHall effect with lots of spatial enhancement.
Custom 1: Psychorus
Custom 2: Comp Ratio/Thrshld
Custom 3: Expand ratio/Thrshld
Custom 4: High Cut
- 4.9 Gen. Ambi** **ADJUST: None**
Keywords: Ambience
 A generic ambience effect. Use this as a starting place to make your own ambience effects.

**Program Bank P2
Plates**

Instrument

- 0.0 Just Plate** **ADJUST: Liveness**
Keywords: Plate, Instrument, Large
 A basic plate, good for any kind of sound source.
- 0.1 Rich Plate** **ADJUST: Decay**
Keywords: Plate, Instrument
 An old standard, bright and diffuse.
- 0.2 Gold Plate:** **ADJUST: Size & Decay**
Keywords: Plate, Instrument
 A classic plate with a long decay and medium high end response.
- 0.3 Plate4Brass** **ADJUST: Rt HC**
Keywords: Plate, Instrument
 A good plate for brass sounds.

- 0.4 Rock Plate** **ADJUST: Out Width** **P2 Plates cont'd.**
Keywords: Plate, Instrument, Large
 A big boomy dark plate with a moderate reverb tail great for high frequency sound sources where you do not want to add more high end.
- 0.5 Eko Plate** **ADJUST: Mstr Delay**
Keywords: Plate, Instrument, Echo, Guitar
 A sweet combination of recirculating pre-echoes and bright sounding reverb, great for guitar and keys.
- 0.6 A.Gtr Plate** **ADJUST: Dly Lvl**
Keywords: Plate, Instrument, Guitar
 A really smooth plate with a slow reverb build that great for acoustic guitar. ADJUST allows you to mix in delay.
- 0.7 SynthLdBPM** **ADJUST: Delay Lvl**
Keywords: Plate, Keyboard, Echo, Tempo
 A medium bright plate with tempo delays optimized for use with synth patches. **Tap** allows you to tap in the tempo of the delays.
- 0.8 Floyd Wash** **ADJUST: In Width:OutWidth**
Keywords: Plate, Instrument, Echo, Guitar
 A big plate reverb with long predelay and repeating echo delays adds a spacey wash to slow program material. Great for guitar and synth sounds. ADJUST controls a custom In Width/Out Width parameter that changes the spatial feel.
- 0.9 GtrPlateBPM** **ADJUST: Dry Dly**
Keywords: Plate, Guitar, Echo, Tempo
 A moderate size dark plate reverb optimized for guitar with tempo driven delays to fatten up the sound. **Tap** in the tempo of the delays.

Vocal

- 1.0 Vocal Plate** **ADJUST: Decay**
Keywords: Plate, Vocal, Short
 A short plate with low diffusion great for a solo vocal track.
- 1.1 Vocal Plate2** **ADJUST: Liveness**
Keywords: Plate, Vocal, Large
 A large plate with a moderate decay time, great for backing vocals.
- 1.2 SmVoxPlate** **ADJUST: Decay**
Keywords: Plate, Vocal, Small
 A small bright plate that's good for vocals.
- 1.3 VociEkoPlate** **ADJUST: PreDelay**
Keywords: Plate, Vocal, Echo
 A large dark plate with just the right amount of delay to enhance vocal tracks.
- 1.4 Choir Plate** **ADJUST: Choir Size & Type**
Keywords: Plate, Vocal, Large
 A large silky plate with a long decay time, great for background vocals. ADJUST controls the choir from big and breathy to small and short.
- 1.5 Multi Vox** **ADJUST: Size & Decay**
Keywords: Plate, Vocal, Short
 A small short plate great for gang vocals. ADJUST simultaneously controls Size and Decay from small and short, small and long, medium and short, medium and long, and large and long.

- P2 Plates cont'd.**
- 1.6 Bright Vox** **ADJUST: Darkknob**
Keywords: Plate, Vocal, Bright
 A large bright plate with a long decay time, great for various vocals. ADJUST controls the high and low frequency response of the plate.
- 1.7 VocalEcho BPM** **ADJUST: Dry Signal Pan**
Keywords: Plate, Vocal, Echo, Tempo
 A silky smooth plate with moderate decay time and recirculating delays, great for all vocals.
- 1.8 VocalTapBPM** **ADJUST: Reverb Level**
Keywords: Plate, Vocal, Echo, Tempo
 Similar to VocalEchoBPM with different delay taps.
- 1.9 VocalTapBPM2** **ADJUST: Size**
Keywords: Plate, Vocal, Echo, Tempo
 Similar to VocalEcho BPM with a more linear straight BPM delay. ADJUST lets you choose from five room sizes.

Live Sound

- 2.0 Live Plate** **ADJUST: Decay**
Keywords: Plate, Live PA, Bright
 A crisp clean basic plate with medium decay time and low bass response optimized for live PA applications.
- 2.1 Clean Plate** **ADJUST: Diffusion**
Keywords: Plate, Live PA, Bright
 A clean plate with ADJUST control of diffusion.
- 2.2 Live Gate** **ADJUST: Gate or Inverse**
Keywords: Plate, Live PA, Gated, Special FX
 Change from a tight gate or crisp inverse sounds on the fly. ADJUST controls the choice from Gate to Inverse.
- 2.3 Bright Plate** **ADJUST: Liveness**
Keywords: Plate, Live PA, Bright
 A small bright plate with short decay time. Great for enhancing an instrument without overpowering it.
- 2.4 Hot Plate** **ADJUST: Plate Temperature**
Keywords: Plate, Live PA, Bright
 A medium sizzling plate optimized for live sound mixing, good for all material. ADJUST allows you to modify the high frequency of the plate.
- 2.5 Ever Plate** **ADJUST: Decay**
Keywords: Plate, Large, Dynamic
 Mono Level is patched to Attack and Spread making this an ever-changing plate.
- 2.6 Warm Plate** **ADJUST: Decay**
Keywords: Plate, Live PA, Dark
 A slightly warmer plate for those situations where you don't want as much edge. Try on a solo acoustic guitar performance.
- 2.7 Live Drums** **ADJUST: High Cut**
Keywords: Plate, Live PA, Drums/Perc, Bright
 A medium plate with short reverb time great for a full kit! ADJUST gives you a high cut filter with five EQ choices.

2.8 Great Plate **ADJUST: Decay** **P2 Plates cont'd.****Keywords: Plate, Live PA, Instrument**

A basic plate that will work well with most any sound source. Not too dark and not too bright!

2.9 PlateDlyBPM **ADJUST: Reverb Lvl****Keywords: Plate, Live PA, Echo, Tempo**

This preset can be a plate reverb, a tap tempo delay or both!

Drums&Perc.**3.0 Big Drums** **ADJUST: Size****Keywords: Plate, Live PA, Drums/Perc**

A medium size plate with high diffusion and moderate decay time.

3.1 Drum Plate **ADJUST: Decay****Keywords: Plate, Live PA, Drums/Perc, Dark**

A large dark plate with high diffusion and a long decay time. This is the ultimate drum plate!

3.2 Fat Drums **ADJUST: Reverb Attack****Keywords: Plate, Drums/Perc**

A moderate sized deep sounding plate with a high attack time. ADJUST controls a combination of predelay, reflections and Rt HC.

3.3 Cool Plate **ADJUST: Liveness****Keywords: Plate, Drums/Perc, Short, Dark**

A short dull plate good for percussion.

3.4 Tight Plate **ADJUST: Decay****Keywords: Plate, Drums/Perc, Small**

Small and tight with moderate diffusion. Use this to add punch to any percussion track.

3.5 Short Plate **ADJUST: Decay****Keywords: Plate, Drums/Perc, Short**

A short plate reverb with a fairly short decay time and good high end, great for a full kit.

3.6 Dark Plate **ADJUST: Diffusion****Keywords: Plate, Drums/Perc, Dark, Long**

A classic! Dark and smooth with a long decay time. This fattens any percussion track.

3.7 Plate Gate **ADJUST: Pre Delay****Keywords: Plate, Drums/Perc, Gated**

A gate with the tonal qualities of a plate. The ultimate drum gate!

3.8 Plate Gate 2 **ADJUST: Size****Keywords: Plate, Drums, Gated**

A heavy dense and short nonlinear reverb designed to emulate a plate. ADJUST gives you five different size settings to choose from.

3.9 Bongo Plate **ADJUST: Diffusion****Keywords: Ambience, Drums/Perc, Bright**

Give bongo and native drums thickness with this preset. ADJUST allows you to smooth out the sound.

P2 Plates cont'd.**Custom**

- 4.0 Plate 90** **ADJUST: Attitude**
Keywords: Plate, Dark, Instrument, Custom
 A general purpose, dark plate. ADJUST gives you attitude which ranges from soft and short to harsh and dry. Custom Controls allow you to control the Reverb Density and delay levels. Play with all three of these controls to make your own plate
Custom 1: Reverb Density
Custom 2: Delay Lvlis
- 4.1 WhatTheHeck?:** **ADJUST: LFO2**
Keywords: Plate, Spatial, Tempo, Custom
 Need we say more? A tap tempo-controlled LFO 1 modulates the High Cut parameter. ADJUST controls the speed of LFO 2 which modulates the OutWidth parameter.
Custom 1: Dly Lvlis
Custom 2: Reverb Density
- 4.2 GtrDlyPlate:** **ADJUST: Delay Separation**
Keywords: Plate, Guitar, Echo, Custom
 A basic guitar delay with some plate reverb mixed in. ADJUST lets you choose 100ms, 150ms, 250ms, 500ms, and 1 second delays. Custom 1 allow you to control the Width, from mono to stereo.
Custom 1: Width
- 4.3 Patterns BPM:** **ADJUST: LFO Rate**
Keywords: Plate, Spatial, Tempo, Custom
 A tempo-driven spatial effect that moves delays around the room. ADJUST controls the LFO rate which is patched to Out Width. Slow it down or speed it up for more dramatic spatial effects Works great with any sound source!
Custom 1: Dly Lvlis
- 4.4 MultiPlateDly:** **ADJUST: Tap Delay Speed**
Keywords: Plate, Echo, Instrument, Custom
 A multi-purpose plate delay. ADJUST control the tap speed of the echo delays. Custom Control 1 simultaneously controls InWidth and OutWidth for some unique spatial effects. Custom 2 controls the delay levels for the reflections and the dry delays. Custom 3 controls the reverb liveness.
Custom 1: In Width:Out Width
Custom 2: Dly Lvlis
Custom 3: Liveness
- 4.5 MonoOrStereo:** **ADJUST: Mono or Stereo**
Keywords: Plate, Instrument, Custom
 A general plate that can be run in mono, stereo or 3 choices in between.
Custom 1: Liveness
- 4.6 TapDelayBPM:** **ADJUST: Eko Feedback Decay**
Keywords: Plate, Echo, Tempo
 An all purpose tap tempo delay with a small amount of plate reverb.
Custom 1: Dly & Ref Lvlis
- 4.7 Spatial Plate:** **ADJUST: LFO 1 & 2**
Keywords: Plate, Spatial, Custom
 A spatial plate reverb with LFO 1 & 2 each independently controlling InWidth and OutWidth scaled inversely. ADJUST gives you three choices for LFO speed.
Custom 1: Reverb Density

4.8 PanEkoBPM: ADJUST: Panning Speed P2 Plates cont'd.**Keywords: Plate, Echo, Tempo, Custom**

LFOs modulate dry reflections levels to give you a panning effect. Use **Tap** to tap in the desired delay time. ADJUST controls the panning speed while Custom 1 controls InWidth and OutWidth — these parameters are inversely scaled to produce some interesting spatial effects.

Custom 1: In Width:Out Width**4.9 Gen. Plate: ADJUST: Not Patched****Keywords: Plate**

A generic plate preset. Use this as a starting point to make your own plate presets.

Indoor Small**Program Bank P3
Post****0.0 Cabin Fever ADJUST: Decay****Keywords: Cncrt Hall, Indoor, Small.**

Sounds like you've been snowed in too long! Basically a dead space — muffled and not much width. ADJUST provides some variation in the response of this small space.

0.1 Echo/Kitchen ADJUST: Blend**Keywords: Splits, Indoor, Small**

A split program providing a syncopated echo delay, and a reverb like the inside of a small kitchen. ADJUST controls the blend of the two effects

0.2 HardwoodRoom ADJUST: Size**Keywords: Ambience, Indoor, Small, Room**

Designed to sound like a room with a hardwood floor. Select room size with ADJUST.

0.3 MeetingRoom ADJUST: Decay**Keywords: Ambience, Indoor, Small, Room.**

Hotel-like meeting room. Predelay is set to 46ms, so the wet mix sounds like the microphone is at the back of the room.

0.4 Locker Room ADJUST: Decay**Keywords: Ambience, Indoor, Small, Room**

The ambience of a locker room.

0.5 Living Room ADJUST: Size**Keywords: Ambience, Indoor, Small, Room**

A softer room with a short Rt and some of the stereo width removed.

0.6 Bedroom ADJUST: Size**Keywords: Cncrt Hall, Indoor, Small, Room**

A small bedroom with furniture and heavy curtains. Good on lots of instruments and drums.

0.7 Dual Closets ADJUST: Blend**Keywords: Split Rvb, Indoor, Small**

A split effect providing an empty closet, and a full closet. ADJUST controls the blend between the two.

0.8 Phone Booth ADJUST: Size**Keywords: Ambience, Indoor, Small.**

How much sound can you squeeze into a phone booth? Adds a bit of space to all sounds. Custom Control 1 links pre delay, dry delay, and dry delay mix to easily change the characteristics of the booth.

Custom 1: Delay Mix 0 - 100

P3 Post cont'd. 0.9 Coffin ADJUST: Mix**Keywords: Ambience, Indoor, Small.**

Simulate a tight small space with this ambience preset. ADJUST controls dry delay mix to brighten or deaden the sound for an open or closed casket.

Indoor Large**1.0 MetalChamber ADJUST: Decay****Keywords: RandomHall, Indoor, Large, Room**

Short, boomy, and bright. Like the inside of an anechoic chamber without the absorption cones.

1.1 Stairwell ADJUST: Number Of Floors**Keywords: Cncrt Hall, Indoor, Large**

Short decay of a single room, to large reflections lost in the high-rise. ADJUST lets you select from 20 floors.

1.2 Make-A-Space ADJUST: Decay**Keywords: RandomHall, Indoor, Large, Custom**

ADJUST and Liveness controls let you quickly design your own space.

Custom 1: Liveness 0 - 127**1.3 Diy/Hallway ADJUST: Blend****Keywords: Splits, Indoor, Large, Echo**

A split program with a short ping-pong delay, and a medium-long hallway reverb. ADJUST.

1.4 LectureHalls ADJUST: Blend**Keywords: Splits, Indoor, Large**

A split program with an "empty" hall and a "full" hall.

1.5 Dance Hall ADJUST: Decay**Keywords: RandomHall, Indoor, Large**

Preset at 1.4 seconds of reverb time for a medium bright hall, or use ADJUST to customize.

1.6 Ballrooms ADJUST: Blend**Keywords: Splits, Indoor, Large, Room**

A split program providing two different shaped ballrooms: a rectangular-shaped room with strong reflections and a fan-shaped room with a smooth decay.

1.7 Empty Club ADJUST: Decay**Keywords: RandomHall, Indoor, Large, Empty**

Typical Monday night at the club. Reflections and delays simulate the emptiness.

1.8 NYC Clubs ADJUST: Blend**Keywords: Splits, Indoor, Large**

A split program with the acoustics of two famous New York City nightclubs.

1.9 Sports Verbs ADJUST: Blend**Keywords: Splits, Indoor, Large**

A split reverb with the inside of a locker room, and a large empty arena.

Outdoor**P3 Post cont'd.**

- 2.0 Inside-Out** **ADJUST: Decay**
Keywords: Cncrt Hall, Outdoor, Spatial, Special FX
 A strange hall reverb where the input envelope controls the output width of the reverb. At high levels the signal goes mono. As it decays, the sound fills out the stereo field.
- 2.1 Outdoor PA** **ADJUST: Mix**
Keywords: Ambience, Outdoor, Echo
 Open space, not much reflection. Takes advantage of maximum DryDly time with no Pre Delay to provide a simple outdoor echo. Use ADJUST to mix in the right amount of dry delay level.
- 2.2 Outdoor PA 2** **ADJUST: Decay/DecayLvl**
Keywords: Ambience, Outdoor
 Similar to Outdoor PA. ADJUST provides five different settings.
- 2.3 Two Autos** **ADJUST: Blend**
Keywords: Splits, Outdoor
 A split program giving you the inside of a VW van and the inside of a VW bug. Use ADJUST to control the blend between the two.
- 2.4 NYC Tunnels** **ADJUST: Blend**
Keywords: Splits, Outdoor, Large, Long
 A split reverb simulating two of NYC's automobile tunnels: the Lincoln and the Holland.
- 2.5 Indoors/Out** **ADJUST: Blend**
Keywords: Splits, Outdoor, Indoor
 A split program with a medium chamber and an outdoor response.
- 2.6 Echo Beach** **ADJUST: Mstr Delays**
Keywords: Splits, Outdoor, Echo, Custom
 Echo, echo, echo. Use Custom Control 1 to select between the two echoes.
Custom 1: Echo Chamber/Room
- 2.7 Block Party** **ADJUST: Pre Delay**
Keywords: Cncrt Hall, Outdoor, Custom
 The music reflects off of the brick buildings and paved surfaces, down alley ways and up to the rooftops throughout the neighborhood.
Custom 1: Liveness
- 2.8 Stadium** **ADJUST: Decay**
Keywords: RandomHall, Outdoor, Custom
 Designed to simulate a large sports stadium.
Custom 1: Liveness
- 2.9 Dull/Bright** **ADJUST: Blend**
Keywords: Splits, Bright, Dark
 A split reverb with a dull backstage sound, and a large open space.

P3 Post cont'd.**Spatial**

- 3.0 Wobble Room** **ADJUST: Delay Lvl**
Keywords: RandomHall, Spatial, Room, Custom
 An LFO drives OutWidth to make the room wobble. A Custom Control allows you to set the LFO rate.
Custom 1: Rate
- 3.1 Spatializer** **ADJUST: Out Width**
Keywords: Cncrt Hall, Spatial, Special FX, Custom
 Compress and Expand ratios are cranked. A Custom Control allows you to vary liveness from dull to bright. Compression and expansion parameters are available in the Soft row.
Custom 1: Liveness
- 3.2 Mic Location** **ADJUST: Delay Mix**
Keywords: Ambience, Spatial
 Use bipolar ADJUST to add Predelay or Dry Delay effects; center position is dry close mic. Mono drops out at either extreme.
- 3.3 Voices?** **ADJUST: More Voices**
Keywords: RandomHall, Spatial, Dialog, Custom
 Get lost in the crowd. ADJUST sets the delays to produce multiple voices.
- 3.4 Voices? 2** **ADJUST: More Voices**
Keywords: RandomHall, Spatial, Dialog, Custom
 Similar to Voices? with OutWidth controlled by an LFO for a maddening spatial effect. ADJUST sets the delays. Custom Control 1 sets the rate, decreasing depth as rate is increased to maintain smooth transistions.
Custom 1: Rate
- 3.5 Voices? BPM** **ADJUST: More Voices**
Keywords: RandomHall, Spatial, Custom, Tempo
 Tempo drives individual left/right delays while ADJUST sets delay masters. As in Voices? 2, OutWidth is modulated by an LFO, with rate set by Custom Control 1.
Custom 1: Rate
- 3.6 MovingDelays** **ADJUST: High Cut**
Keywords: Plate, Spatial, Special FX
 An LFO modulates OutWidth to produce wildly moving echoes with left and right delays 50 ms apart.
- 3.7 Window** **ADJUST: Window**
Keywords: Plate, Spatial, Special FX
 The sound source is on the opposite side of windows that can be opened or closed with ADJUST.
- 3.8 Wall Slap** **ADJUST: Decay Lvl**
Keywords: Ambience, Spatial, Custom
 Use ADJUST to determine the wall texture. Custom Control 1 links predelay, dry delay, and the dry delay mix; fully clockwise is dry, anything less introduces ambience.
Custom 1: Delay Mix
- 3.9 BombayClub** **ADJUST: Location**
Keywords: Ambience, Spatial, Indoor, Custom
 ADJUST varies Decay, Out Width, and High Cut, to simulate different locations within the club. Custom Control 1 links predelay, dry delay, and the dry delay mix; fully clockwise is dry, anything less introduces ambience.
Custom 1: Delay Mix

Custom

P3 Post cont'd.

4.0 X Variable**ADJUST: Decay****Keywords: Cncrt Hall, Indoor, Custom**

Custom Controls are the solution to this variable equation. Custom 1 links Rt HC, Crossover, and Shape to vary liveness from dull to bright. Custom 2 links Reflect Mstr Dly and Size to setup different reflections; 0 is all pre delay with no reflections. Predelay is located in the Soft row for convenience.

Custom 1: Liveness**Custom 2: Reflections****4.1 Y Variable****ADJUST: Decay****Keywords: RandomHall, Large, Indoor, Custom**

Random Hall version of X Variable. Here, Custom 2 varies reflections, 0 is all Delay with no reflections. Delay parameters are located in the Soft row for convenience.

Custom 1: Liveness**Custom 2: Reflections****4.2 Sound Check****ADJUST: Decay****Keywords: Cncrt Hall, Indoor, Large, Custom**

Imagine an empty hall, club, or arena from the perspective of the stage. ADJUST lets you choose the venue.

Custom 1: Liveness 0 - 127**Custom 2: Reflections 0 - 50****4.3 Sound Stage****ADJUST: Decay****Keywords: Ambience, Live PA, Indoor, Custom**

For variations in ambience, try using Custom Control 1 to change Pre Delay/Dry Delay mix.

Custom 1: Delay Mix**4.4 BPM Looper****ADJUST: Response****Keywords: Plate, Custom, MIDI, Tempo**

Tempo drives a mod row time switch which ramps delay feedback for interesting looping effects. ADJUST varies delay/decay response. Great for wild drum machine rhythms with Tempo Source set to MIDI.

Custom 1: Attitude**4.5 Reverse Taps****ADJUST: Decay****Keywords: Cncrt Hall, Custom, Special FX, Tempo**

ADJUST provides five choices of Mid Rt from 0.292 sec to 32.49 sec. Tempo sets Reflect Dly L/R to vary the reverse effect.

Custom 1: Liveness**Custom 2: Reflections****4.6 Air Pressure****ADJUST: Compress/Expand****Keywords: Cncrt Hall, Broadcast, Dialog, Custom**

Use either compression or expansion with the bipolar functionality of ADJUST. Custom 1 allows you to add some reverb if desired.

Custom 1: Reflections 0 - 50**4.7 The Tomb****ADJUST: Decay****Keywords: RandomHall, Large, Dark, Custom**

Places source material within a very reflective tomb. ADJUST moves the source deeper into this scary space. Use the Custom Controls for additional variations in darkness.

Custom 1: Liveness**Custom 2: Reflections**

- P3 Post cont'd.**
- 4.8 Mythology** **ADJUST: Decay**
Keywords: RandomHall, Dialog, Unnatural, Custom
 Size and delay are inversely proportionate to Custom 3; long delay with minimal size at 0, large size with half the delay at 50. Great for supernatural dialog, or Indian film music vocals.
Custom 1: Liveness
Custom 2: Rate
Custom 3: ReverseReflect
- 4.9 Mr. Vader** **ADJUST: Special Effect Type**
Keywords: Plate, Dialog, Special FX, Custom
 Use ADJUST to select Buzzing or Modulated special effects for out-of-this-world voice or techno-pop.
Custom 1: Attitude
Custom 2: Rate

Program Bank P4 Splits

Mono

This row consists of dual independent mono input machines with a combined stereo output. This row (and portions of other rows) may be utilized fully when each input is connected to a dedicated effect send on a console, giving the PCM 90 a dual machine operation.

- 0.0 Chamber/Room** **ADJUST: Chamber/Room**
KeyWords: Splits, Chamber, Room, Mono
 A fine example of the dual functionality and quality of the Chamber/Room algorithm. Set up as two independent reverberators, ADJUST allows you to monitor the Chamber, the Room or both.
- 0.1 Two Chambers** **ADJUST: Wood/Brick**
KeyWords: Chamber, Drums, Splits, Mono
 The Brick Chamber has a live reflective sound while the Wood Chamber is designed to be dark and more dense.
- 0.2 Hall/Room** **ADJUST: Hall/Room**
KeyWords: Splits, Large, Small, Mono
 The Chamber reverb is configured to sound like a large hall, and the Room reverb maintains its smaller size and depth.
- 0.3 Mono Halls** **ADJUST: Left Hall, Right Hall**
KeyWords: Splits, Large, Mono
 This dual purpose program splits the left and right inputs to each reverberator, both of which are tailored to emulate halls.
- 0.4 LgKick/Snare** **ADJUST: Kick/Snare**
KeyWords: Large, Drums/Perc, Splits, Mono
 This Program is meant to be dedicated to the kick drum and snare drum. ADJUST allows you to monitor a single input while Input Configuration in the Soft row allows you to switch the effect for each instrument.
- 0.5 Keys Room** **ADJUST: Clavinet/Organ**
KeyWords: Splits, Chamber, Keyboard, Mono
 Two Rooms designed specifically for use with Clavinet and Organ. ADJUST lets you swap the input into each Room.

0.6 Two Guitars ADJUST: Gtr1/Gtr2 **P4 Splits cont'd.****KeyWords: Splits, Acoustic, Guitar, Mono**

Designed with a duo in mind, the Acoustic guitar space is fairly small and ambient, while the Electric guitar is in a large wash with a bit of echo.

0.7 Fusion BD/SN ADJUST: Kick/Snare**KeyWords: Splits, Drums, Small, Mono**

Ideal for adding live Room ambience to the kick drum and snare drum. This program is very useful when set up with a console for two independent auxiliary sends; the Soft row has a parameter for swapping the inputs.

0.8 Dual Drums ADJUST: Chamber/Room**KeyWords: Splits, Drums/Perc, Mono**

Similar to Fusion BD/SN, this preset is made up of two great drum rooms.

0.9 SmKick/Snare ADJUST: Kick/Snare**KeyWords: Splits, Drums/Perc, Small, Mono**

A smaller version of LgKick/Snare dedicated to snare and bass drums.

Stereo

This row utilizes the stereo input configuration of the Chamber/Room algorithm resulting in two stereo-in, stereo-out effects.

1.0 Vocal Verbs ADJUST: Lead/Backing**KeyWords: Vocal, Echo, Splits, Stereo**

A reverb designed for background vocals, and one designed for lead vocals.

1.1 Studio Rooms ADJUST: StudioA/Studio B**KeyWords: Room, Chamber, Splits, Stereo**

Provides two different sounding studio rooms. Good for all program material.

1.2 Hard Rooms ADJUST: Smooth/Ragged**KeyWords: Room, Short, Splits, Stereo**

A ragged, bright small, hard room, and a smooth, medium large room.

1.3 Random Rooms ADJUST: Rarely /Very Often**KeyWords: Special FX, Drums, Splits, Stereo**

A large room is triggered in place of the small, constantly running Chamber. ADJUST controls the speed of LFO1's Random waveform output, which in turn, is used to trigger the AR Envelope providing a smooth transition from the small Chamber to the Large Room.

1.4 Hall/Basemnt ADJUST: Hall/Bsmnt**KeyWords: Room, Chamber, Splits, Stereo**

A nice hall reverb, and a basement-like room.

1.5 Breath ADJUST: Pre Delay**KeyWords: Splits, Large, Stereo**

A dual reverb program with very large Size and Pre Delay.

1.6 Cathedrals ADJUST: St. Peters/St. Johns**KeyWords: Large, Splits Stereo**

The inside of two cathedrals.

1.7 Castle Chmbr ADJUST: Rt HC**KeyWords: Bright, Splits, Stereo**

An all-purpose Chamber with Reverb Time High Cut patched to ADJUST.

- P4 Splits cont'd.**
- 1.8 Warm Dual** **ADJUST: Chamber/Room**
KeyWords: Dark, Room, Splits, Stereo
 A Chamber and a Room edited to have very low high frequency content.
- 1.9 Rvb+DryDelay** **ADJUST: Stereo Delay Level**
KeyWords: Splits, Echo, Vocal
 When the stereo reverb effect decays to silence, a slightly panned dry-signal delay is heard. This effect is Tempo based — the delays and reverb tail scale with BPM.
- Live Sound**
- Designed for Live Sound applications, all delay programs have their delays based on Tap Tempo. Programs 2.7 - 2.9 are dual mono input machines with a combined stereo output.
- 2.0 Dlvs/HallsBPM** **ADJUST: Delays/Reverb**
KeyWords: Echo, Tempo, Splits, Live PA
 A split program with a basic hall, and dual Tap-Tempo delays.
- 2.1 Split Elvis** **ADJUST: Slap-back echo**
KeyWords: Special FX, Echo, Splits, Live PA
 Two slap-back echo effects: a large slap echo, and a small slap with Room ambience.
- 2.2 Room In Room** **ADJUST: Big/Small Room**
KeyWords: Room, Splits, Live PA, Stereo
 A split reverb with a small room and a large pre-delayed room. Combined, they provide a "small room in a large room" effect. Separately, they are useful as standalone rooms.
- 2.3 Bloom Verbs** **ADJUST: Short/Long**
KeyWords: Drums/Perc, Stereo, Splits, Live PA
 A long, "Blooming" reverb that rises and decays, and a short Bloom verb. Good on all types of sounds.
- 2.4 DualEcho BPM** **ADJUST: Echo 1/Echo 2**
KeyWords: Echo, Splits, Live PA, Stereo
 A split effect with two different echo patterns, creating a syncopated echo/delay. ADJUST controls the blend between the two effects.
- 2.5 Chords/Leads** **ADJUST: Chords, Leads**
KeyWords: Splits, Guitar, Live PA, Stereo
 A large hall with Tap Tempo based Reflections for added delay and a small room for chord comping. The AR Envelope generator makes the crossfade between the two effects.
- 2.6 Two Delays** **ADJUST: Delay 1/Delay 2**
KeyWords: Echo, Stereo, Splits, Live PA
 A split program with two different delay types: a syncopated multi delay, and a modulated resonant delay with LFO2 controlling Master Delay and Master Feedback.
- 2.7 Gloss & BPM** **ADJUST: Gloss**
KeyWords: Echo, Mono, Splits, Live PA
 The left input feeds a Tap Tempo based stereo delay while the right channel comprises a large glossy reverb designed to add shine to the mix. Controls in the Soft row allow you to change the input assignments and adjust the amount of recirculation within the echoes.
- 2.8 BPMVox/Drums** **ADJUST: Vocal Decay Time**
KeyWords: Splits, Live PA, Splits, Mono
 The left input feeds a large vocal reverb combined with a Tap Tempo based diffused echo. The right channel feeds a medium sized drum room with the bass response rolled off around 270 Hz.

2.9 DualDelayBPM **ADJUST: Ganged Delay Hi Cut** **P4 Splits cont'd.**

KeyWords: Splits, Echo, Live PA, Tempo

Tap Tempo based dual delays. These can be inserted in a console as two independent mono delays.

Instrument

The Programs in this bank have been created for specific instrument applications. Programs 3.5 - 3.9 are independent mono input machines with a combined stereo output.

3.0 Symphonic **ADJUST: Decay**

KeyWords: Splits, Classical, Large, Instrument

This program uses the Chamber portion of the Chamber/Room algorithm to emulate a large dark hall. This orchestral setting is good for large vocal choirs, strings, and dark brass instruments.

3.1 Bass Mics **ADJUST: Blend**

KeyWords: Guitar, Instrument, Splits, Stereo

This split program provides two mic'd bass amps: one close mic'd and one a bit farther away.

3.2 Dyna Room **ADJUST: Large Room Decay**

KeyWords: Instrument, Short, Long, Splits

Similar to Random Rooms, but with input level used to kick in the large Room.

3.3 TwoDrumRooms **ADJUST: Blend**

KeyWords: Drums, Room, Splits, Instrument

A large, bright room with strong early reflections and a far mic, combined with a medium large room with smoother response and a close mic.

3.4 Full Kit **ADJUST: Size**

KeyWords: Splits, Chamber, Drums/Perc, Instrument

A multi-purpose Chamber most suitable for adding life to a full drum kit.

3.5 Perc/Synth **ADJUST: Blend**

KeyWords: Drums/Perc, Keyboard, Splits, Instrument

A room reverb for percussion, and a reverb for synth washes.

3.6 Rhodes/Brass **ADJUST: Rhodes/Brass**

KeyWords: Keyboard, Splits, Instrument

This program is intended for keyboard instruments. The Brass reverb is highly reflective to accentuate keyboard samples. The Room reverb is tailored for the classic Fender Rhodes.

3.7 Organ/Piano **ADJUST: Organ/Piano**

KeyWords: Acoustic, Keyboard, Splits, Instrument

A room for organ sounds, and a hall for pianos.

3.8 Brass/String **ADJUST: String/Brass**

KeyWords: Keyboard, Instrument, Splits, Mono

A reverb suited for bright brass instruments, and one designed for strings.

3.9 Guitar Verbs **ADJUST: Gtr1/Gtr2**

KeyWords: Instrument, Guitar, Splits, Mono

A dual reverb for electric and acoustic guitars.

P4 Splits cont'd.**Custom****4.0 Thunder&Ice** **ADJUST: Effects Blend****KeyWords: Splits Special FX, Spatial, Custom**

Two completely opposite reverbs at your disposal. Use ADJUST to blend or separate the short, bright Room and the big and thunderous Chamber. For a backwards effect, go to Custom 1. To change the In Routing configuration, use Custom 2. Custom Controls 3 and 4 are dynamic effects: a switch ramping the Mix from Wet to Dry, with the controller accessing the speed of the ramp, and an LFO patched to the High Cut of the Room (Ice) setting — you can control the rate of oscillation.

Custom 1: Inverse Effects**Custom 2: In Routing****Custom 3: Wet to Dry Ramp****Custom 4: Im-Pulse Ice****4.1 Ring Verb** **ADJUST: Verb to Mod****KeyWords: Splits, Special FX, Spatial, Custom**

This Chamber/Hall preset lets you have a long, bright reverb and an ultra-metallic ring mod. ADJUST lets you blend or separate these two effects. Custom 1 tunes the frequency of the ring mod. Custom 2 lets you change the In Routing status. Enhance your stereo sound with Custom 3, or use Custom 4 to turn up some delay and then **Tap** in the delay time or dial in the BPM.

Custom 1: Mod Tuner**Custom 2: In Routing****Custom 3: Stereo Enhancer****Custom 4: TapReflect Level****4.2 Dark & Brite** **ADJUST: Reverb Blend****KeyWords: Splits, Special FX, Spatial, Custom**

A dark, dense reverb and a bright, thin reverb. Use ADJUST to balance the two. Use the Inverse EQ effect on Custom 1 to cut the highs on the Room while boosting them on the Chamber. Custom 2 lets you change the effect from forwards to backwards, while Custom 3 adds a bit of Pre-delay to the signal. Custom 4 gives you a bit more EQ enhancement.

Custom 1: Inverse EQ**Custom 2: Inverse Effects****Custom 3: Pre Delay****Custom 4: Briteness Enhancer****4.3 Dark & Gated** **ADJUST: Toggle Gate FX****KeyWords: Splits, Special FX, Custom, Gated**

A dynamic effect with input level affecting the Shape setting of the Room, and triggering the Infinite switch on the Chamber reverb. When Infinite triggers, then releases, a gate effect is produced. Use ADJUST to change the Mode of the AR envelope. Use Custom 1 to change the release time of the gate. Custom 2 changes the balance of the Chamber/Room levels, Custom 3 changes their Sizes. Input level also controls a Master Delay line that is active at lower levels, then cuts out and the gate kicks in at higher levels. Use Custom 4 to change the level of this delay.

Custom 1: Gate/Shape Release**Custom 2: Effects Blend****Custom 3: Switch the Sizes****Custom 4: Master Delay Level****4.4 Pipe Reverb** **ADJUST: PipeSize****KeyWords: Splits, Special FX, Bright, Custom**

With all the characteristics of a pipe in mind, this small drain to enormous tunnel reverb is great as a special effect for television or film. Use ADJUST to choose pipe size, or just use Custom 1 to control the basic Size settings. For more control over the EQ, use Custom 2 to change the high frequencies.

Custom 1: Size**Custom 2: High Cut**

4.5 Weird Places **ADJUST: Eko Box/Oil Drum** **P4 Splits cont'd.****KeyWords: Echo, Special FX, Splits, Custom**

A split program with a short "Box" reverb with repeating echo delays, and a reverb like the inside of an Oil drum.

Custom 1: Stereo Delay**Custom 2: Oil Drum Timbre****Custom 3: Oil Drum Texture****4.6 Two Rooms** **ADJUST: Little Thin/Dark Room****KeyWords: Slap FX, Guitar, Splits, Custom**

Two very distinct rooms allows for quick switching between different effects.

Custom 1: Dual Decay**Custom 2: Dual Liveness****4.7 TapDly&Hall** **ADJUST: Tap Delay/Hall****KeyWords: Echo, Bright, Splits, Custom**

This Program places a Tap-Tempo based delay on the left input with a hall reverb on the right input. The Soft row has Custom Controls created for swapping the inputs and adjusting the amount of feedback present in the delays.

Custom 1: Input Assignment**Custom 2: Tap Delay Master****4.8 E-NoseDelays** **ADJUST: Nose 1/Nose 2****KeyWords: Echo, Dynamic, Splits, Custom**

Two very strange delays. One with a highly resonant short delay with Random LFO1 modulating delay time, the other with long modulated delays modulated by LFO2.

4.9 Gen. Split **ADJUST: not patched****KeyWords: Splits, Custom**

A generic Chamber/Room preset. Use this as a starting point to create your own split reverb effects.

5

MIDI Operation

All PCM 90 parameters, programs and registers can be accessed by MIDI. All MIDI applications require the PCM 90 to be connected with one or more MIDI devices with standard MIDI cables via the rear panel MIDI jacks.

Selecting a MIDI Channel

MIDI controls, such as Transmit and Receive Channel selection are available in Control mode Row 3 MIDI. All of these controls are described in Chapter 2. Several are repeated here for your convenience.

Before using the PCM 90 with other MIDI devices, all devices must be set to the same MIDI channel. To set the PCM 90 to receive MIDI:

1. Set the controller you will be using (keyboard, sequencer, other PCM 90, etc.) to transmit on any MIDI channel (1-16).
2. On the PCM 90, press **Control**. Use Select and **Up** or **Down** to locate matrix position **3.1 Receive**.
3. Turn ADJUST to select **OFF**, **1-16**, or **OMNI** for receipt of MIDI messages.

Accessing Programs and Registers

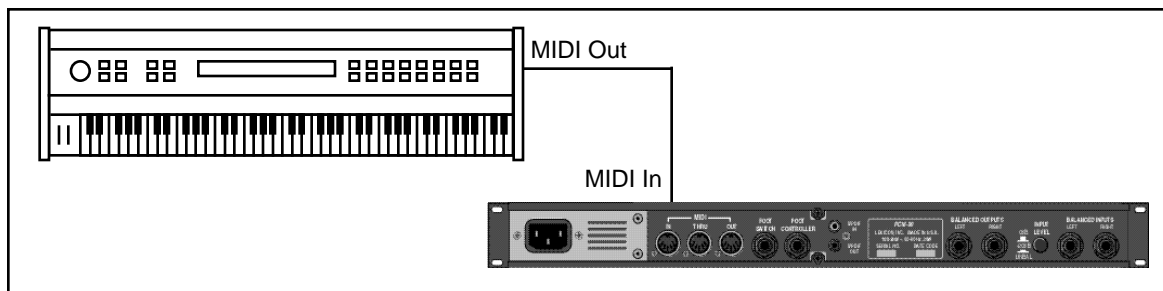

Some extremely useful effects can be created by controlling PCM 90 parameters remotely in real time. Almost all of the controllers found on a MIDI keyboard or MIDI foot controller (pitch benders, mod wheels, sliders, switches, breath controllers, foot pedals and footswitches) can be used to adjust PCM 90 parameters. We refer to this real time remote control capability as Dynamic MIDI®

Sending a MIDI Program Change message (0-49) from the controller will load the corresponding PCM 90 program from the current bank. If any MIDI sources are active as global or general purpose patches, moving the appropriate control on the controller will cause the patched destination parameter to change. (See *Patching*.) If you want to use Dynamic MIDI, but don't want the PCM 90 to load new registers when you change programs on your controller, set your controller so that it doesn't transmit Program Change messages, or set PCM 90 MIDI Program Change to Off at Control mode matrix location 3.3.

Controlling PCM 90 Tempo Rate with MIDI Clock

MIDI Tempo Control

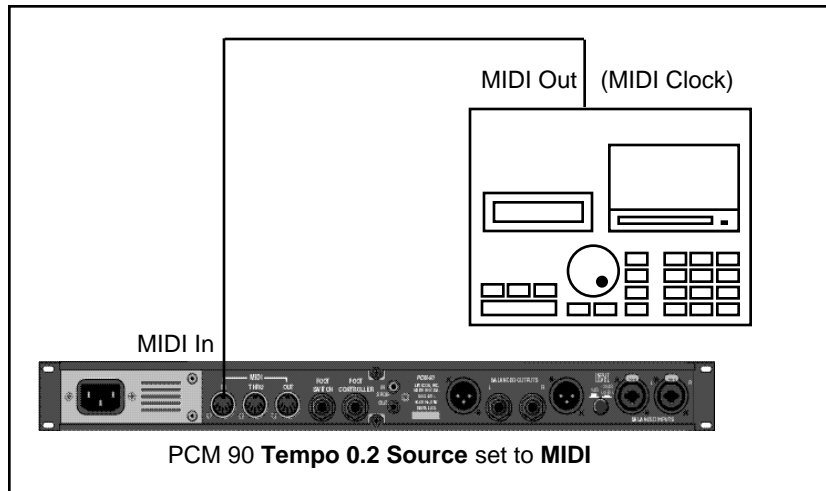

Using the PCM 90 as a MIDI Clock Source

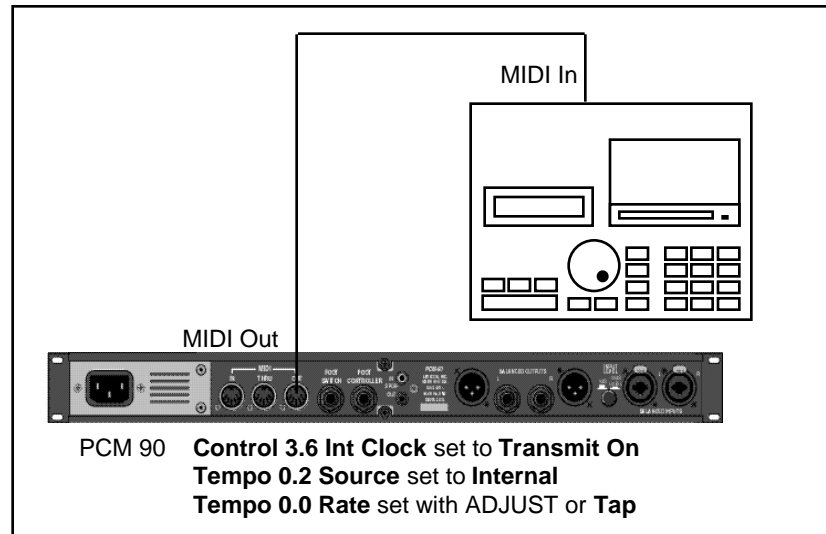

The configuration below shows the MIDI connections for controlling the PCM 90 simultaneously with MIDI Clocks from a sequencer, and messages from another MIDI controller. Note that the controller is set to "local control off" and the sequencer is set to "echo input".

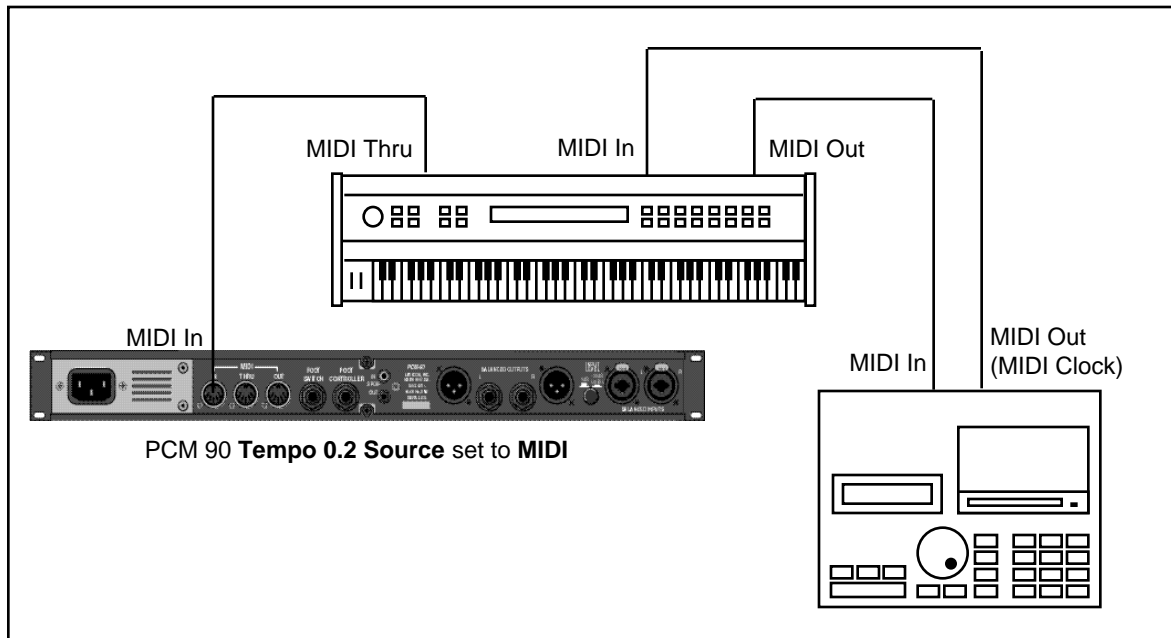

Two PCM 90s can be slaved together by connecting a cable from the MIDI OUT jack of the master to the MIDI IN jack of the slave. Additional PCM 90s can be slaved to the master by connecting a cable from the MIDI THRU port of one slave unit to the MIDI IN port of the next unit. All of the PCM 90s must be set to the same MIDI channel and Device ID.

Slaving two or more PCM 90s

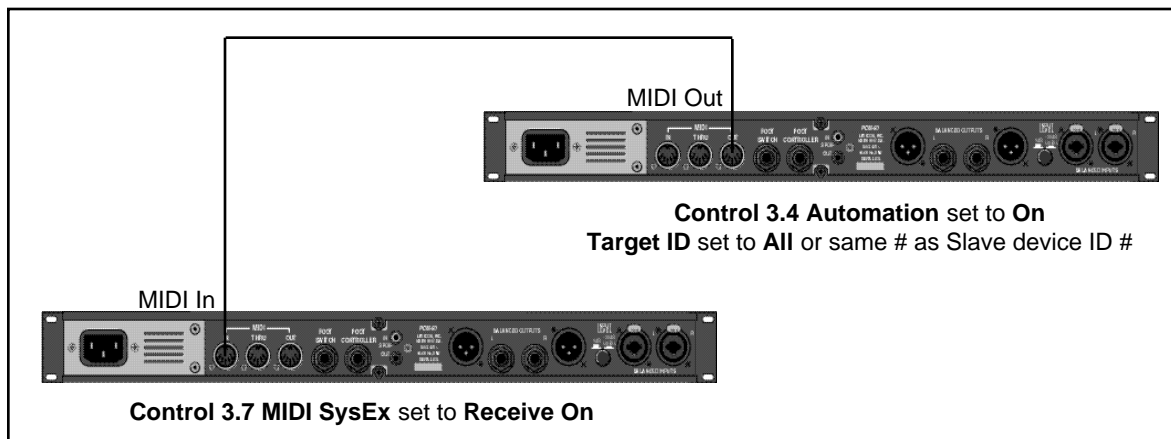

Controller quirks

Some synthesizers and controllers cannot send the full range of MIDI program change messages (1-128). Others may appear to be able to send only 32, but actually have a bank mode that *does* let you send all 128 program change messages. Also, be aware that some MIDI devices use a program numbering system that uses 0-127 instead of 1-128. If in doubt, see the manual for your controller. For reference, in the PCM 90, Program Change 0 will load the effect at 0.0 in the current bank. Program Change 1 will load the effect at 0.1, etc.

The ADJUST Knob, Custom Controls, Foot Pedal, Foot Sw 1 and Foot Sw 2 as MIDI Controllers

You can choose to have the PCM 90 send MIDI Controller messages whenever you turn ADJUST (the soft knob in Program Banks or Register Banks modes), when you modify a Custom Control, or use them to activate analog controllers connected to the rear panel Footswitch or Foot Controller jacks. This makes it possible to record real-time control of PCM 90 effects with a MIDI sequencer — A simple but quite powerful way to automate effects.

To send MIDI data from these controllers, first set Control mode 3.2 (**Transmit**) to the desired MIDI Channel. (The default is Channel 1.)



Once a transmit channel has been set, go to Control mode 3.5 to assign MIDI Controllers. Press **Load/*** to display the available controllers: **Foot Pedal**, **Foot Sw 1**, **Foot Sw 2**, **ADJUST**, or **Custom 1-4**. Turn ADJUST to assign the MIDI Controller data to be sent when the displayed controller is activated. (The default assignment is **None**.)

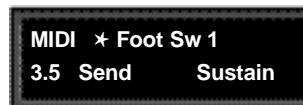

When a PCM 90 controller is assigned to a MIDI Controller, the PCM 90 will respond to incoming controller messages as though its own controller were moved. In other words, if **FootSw1** is assigned to **Sustain**, the PCM 90 will respond to incoming Sustain messages as though Foot Sw 1 had been activated.

Each PCM 90 preset has a unique soft knob patch that allows you to control the effect directly from Program or Register Banks mode with the ADJUST knob. You can also control the soft knob patch remotely from MIDI, or from the Foot Pedal.

Controlling the Soft Knob with MIDI

To control the soft knob with MIDI, set Control mode 3.1 (**Receive**) to the desired MIDI Channel. Set Control mode 3.5 (**ADJUST**) to the desired MIDI Controller such as **Mod Wheel**.

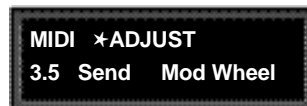

Now, the Mod Wheel on the MIDI instrument will control the soft knob patch of the running effect.

Note: In Program Banks mode, the ADJUST display will not appear when the controller is moved. In this case, ADJUST is still independent of the controller.

If you have a foot pedal connected to the PCM 90 rear panel Foot Controller jack, you can use it to control the soft knob patch. (Note that no MIDI connections are required to do this.)

Controlling the Soft Knob with a Foot Pedal

Set both Control mode 3.5 **ADJUST** and Control mode 3.5 **Foot Pedal** to the same MIDI Controller.

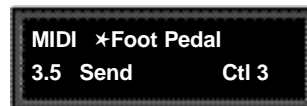
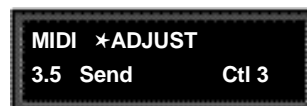

Now, the foot pedal will control the soft knob patch of the running effect. Keep in mind that, if **Patch Update** (System 1.7) is set to **Immediate**, the current value of the controller will be sent to ADJUST when the program is loaded. For example, if your footpedal is at 0, ADJUST will be set to 0 on program load.

Note: Footswitches are transmitted with an On value of 127, and an Off value of 0.

Program Change Messages

Reception of MIDI Program Change and Bank Select messages can be selectively enabled/disabled from Control Mode parameter 3.3, MIDI Pgm Change. The manner in which the PCM 90 interprets these messages is determined by the value of this parameter as follows:

Pgm Change: Off

All Program Change and Bank select messages are treated as "unavailable". Pgm+ and Pgm- will load the next higher or lower program in the current bank, then wrap to the adjacent bank.

Pgm Change : On

Program Change messages 0-49 correspond to PCM 90 Effects 0.0 -4.9 in the current bank. Program Change messages 50—127 are ignored. Pgm+ and Pgm- will load the next higher or lower program in the current bank, then wrap to the adjacent bank.

The current bank can be changed with MIDI Continuous Controller 32 and Bank Select Messages as follows:

- 0-4: Program Banks 0-4
- 5-6: Internal Register Banks R0 and R1
- 7-11: reserved for ROM Card Banks
- 12-...: Memory Card Banks

The number of banks available on a given card will vary with card size as follows:

Card Size	# Banks
64k	1
256k	5
512k	10
1 Meg	20

Pgm Change: Map

Program Change 0-127 can be mapped to any PCM 90 Effect in any internal or card bank. Two 128 element maps are stored internally, additional maps may be stored on RAM cards.

Map 0	Map 1
MIDI 0 = P0 0.0	MIDI 0 = P2 2.8
MIDI 127 = P2 2.7	MIDI 127 = R 4.9

Pgm+ and Pgm- will load the next higher or lower program in the map.

Pgm Change: Chain

Any Program Change number can be selected to load any one of ten customized effect "chains." Once a chain is loaded, effects in the chain are accessed by the controller patched to Pgm + and Pgm - (program increment and program decrement).

Note: The PCM 90 requires a brief amount of time to change programs. Additional Program Change messages received during this time out may be lost.

Automation

SysEx Automation

The PCM 90 will transmit SysEx automation messages when Control Mode parameter 3.4, MIDI Automation is set to On. Almost all changes made by front panel operations are transmitted as PCM 90 SysEx messages. This is intended primarily for use in configurations where it is desirable for one or more PCM 90s to be slaved to a single PCM 90 acting as a master. The current mode (Program Banks, Register Banks, Edit, Control or Tempo) of the slave does not follow the master, but the actual parameter values do. (SysEx automation can also be stored on a sequencer and replayed in real-time. As a general rule, automating more than two or three SysEx program changes at once is not recommended.)

The PCM 90 can receive SysEx messages when Control mode 3.7 MIDI SysEx is set to **Receive On**. Note that when using SysEx automation, the device of the receiving PCM 90 must match the Target ID of the transmitting PCM 90, or the transmitting device must use the All Devices ID.

The Target ID setting can be adjusted from Control 3.4 MIDI Automation. It is selected by pressing **Load/*** after setting Automation to **On**. The default setting for the Target ID is **All**.

The Device ID setting can be adjusted from Control mode 3.7 MIDI SysEx. It is selected by pressing **Load/*** after setting SysEx to **Receive On**. The default setting for the Device ID is **0**.

Controller Automation

For applications where it is desirable to "automate" changes made to PCM 90 effects with its own controls (ADJUST, Custom 1-4, Foot Pedal, Footswitch 1 or Footswitch 2), we recommend assigning the controllers to MIDI destinations and recording the changes with a MIDI sequencer (see Control Mode parameter 3.5, MIDI Destinations).

Reset All Controllers

The PCM 90 recognizes the "Reset All Controllers" message. When received, all patched parameters are reset to their stored values. Patched parameters may also be reset from the PCM 90 front panel —Control Mode parameter 3.0 (the message will be transmitted from the PCM 90 as well).

MIDI Clock and Clock Commands

The PCM 90 recognizes MIDI clock messages when Tempo Mode parameter 0.2, Tempo Source is set to MIDI. Any Delay or Mod row parameter set to display tempo values will be synchronized to the tempo of the incoming MIDI clock.

MIDI Clock and Clock Commands are also available as Dynamic MIDI patch sources. The value of MIDI Clock when used as a patch source is a linear scaling of 0 to 127 (0 = 40 BPM and 127 = 400 BPM). The value of Clock Commands when used as a Dynamic MIDI patch source is 127 for START and CONTINUE and 0 for STOP.

Dynamic MIDI

The following MIDI messages are available as Dynamic MIDI patch sources:

- MIDI Controllers 1-31 and 33-119
- Pitch Bend
- After Touch (Polyphonic and Channel combined)
- Velocity (Note On)
- Last Note
- Low Note
- High Note
- Tempo (40–400BPM is converted to controller range 0-127)
- Clock Commands

These MIDI messages are also available as threshold sources for several Modulation parameters: AR Env, Latch, Sw 1 and Sw 2, and S&Hold. They may also be used as a tap source for controlling Tempo.

MIDI Implementation Details, including System Exclusive documentation, are available to assist experienced programmers in developing software for use with the PCM 90. These can be obtained directly from Lexicon.
Request: PCM 90 MIDI Implementation Details.

Bulk Data Dumps

Control mode 3.8 (**MIDI Dump**) allows selection of the following types of bulk data to be dumped directly from the PCM 90 to another PCM 90, or to editor/librarian software.

Displayed Name	Description
CurrentPgm	Currently running effect
Bank R0-R1	Internal Register Banks
Bank C0-CJ	Card Banks (card must be inserted)
Map 0, 1	Internal Program Change Maps
Map 2-3	Card Program Change Maps (card must be inserted)
Chain 0-9	Internal Program Chains
Chain 10-19	Card Program Chains (card must be inserted)
Int Chains	All Internal Program Chains
Ext Chains	All Card Program Chains (card must be inserted)
Setup C	Current Setup
Setup 0-4	Internal Setups
Setup 5-9	Card Setups

Use ADJUST to select the bulk data type. Press **Store** to transmit the data .

MIDI Implementation Chart

Lexicon PCM 90
Digital Reverberator

Function		Transmitted	Recognized	Remarks
Basic Channel	Default Changed	1 1-16	1 1-16	
Mode	Default Messages Altered	X X	Mode 1, 3 X X	
Note Number		X	0-127	Last Note, Low Note, High Note used as controllers
Velocity	Note ON Note OFF	X	O 9n v = 1-127	used as controller
After Touch	Keys Channel	X X	X O	
Pitch Bend		X	O	
Control Change	1-119	OX	OX	ADJUST, FootPedal, Footswitch 1, and 2, and Custom 1-4 can be assigned controllers 1-119 for MIDI transmit; 32 reserved for bank select
Program Change	True #	X	0-127	See Implementation Details
System Exclusive	Lexicon Real-time non Real-time	OX X X	OX X OX	product ID=6 device ID
System Common	:Song Pos :Song Sel :Tune	X X X	X X X	
System Real Time	:Clock :Commands	OX X	OX OX*	START, STOP and CONTINUE are patchable as a switch: START/CONTINUE=127; STOP=0
Aux Messages	:Local ON/OFF :All Notes OFF :Active Sense :Reset All Controllers	X X X OX	X O X OX	
Notes				

Mode 1: OMNI ON, POLY
Mode 3: OMNI OFF, POLY

Mode 2: OMNI ON, MONO
Mode 4: OMNI OFF, MONO

O : Yes **OX: Selectable**
X : No

6

Troubleshooting

This chapter is intended primarily to help you recognize some common error states which can be corrected from the PCM 90 front panel, or by simple means such as cable replacement. Any error states which are not covered here should be referred to your local dealer for service by a qualified technician.

In a low-voltage, or "brown-out" condition, the PCM 90 will freeze in its current state. None of the controls will have any effect. When power returns to a normal level, the unit will reset itself as though it had just been powered on. If the unit does not reset itself, turn the power OFF, then ON to resume normal operation.

Low Voltage

Temperature extremes may cause the PCM 90 to exhibit unpredictable behavior. If the unit has been subjected to temperatures below 32°F (0°C) or above 95°F (35°C), it should be turned off and allowed to return to normal temperature before use. The unit may be damaged by exposure to temperatures below -22°F (-30°C) or above 167°F (75°C), or by exposure to humidity in excess of 95%. If a unit exposed to such conditions fails to operate after it returns to a normal operating temperature, contact your local service representative.

Overheating

The PCM 90 doesn't respond to MIDI Program Changes.

Check **Receive** control at Control mode 3.1 and make sure it is set to **On**. Check the MIDI Channel selected as well as the MIDI Channel of the transmitting device. Make sure that **Pgm Change** at Control mode 3.3 is set to **On**. Also check MIDI In/Out connections between the units.

Common MIDI Problems

MIDI Program Change numbers are off by 1.

The PCM 90 transmits and recognizes ProgramChange messages 0-127. MIDI devices which transmit 1-128 rather than 0-127, will be off by 1. Simply adjust by 1 when working with such devices.

The PCM 90 doesn't respond to SysEx commands.

Check the **SysEx** setting (and the Device ID selection) at Control mode 3.7.

The PCM 90 does not transmit SysEx Automation commands.

Check the **Automation** setting (and the target device ID selection) at Control mode 3.4.

Operational Problems **The PCM 90 will not lock onto an incoming digital signal.**
Check the cables that you are using. **DO NOT USE ANALOG AUDIO CABLE TO CONNECT DIGITAL AUDIO.**

Also check to make sure that your input signal complies with S/PDIF format standards. The PCM 90 will recognize AES professional format signals from an appropriate connector, but will not necessarily read and transmit encoded information accurately.

No Digital Audio Output
Check the Bypass state for any mute settings.

No Effects Output
Check the setting of Mix Mode at Control mode 1.1. Also verify that any controllers patched to **Input Level**, or **Mix** are not turned off.

Power On Behavior The PCM 90 performs a series of self tests each time it is powered on, then displays the PCM 90 copyright notice. This should be followed by the display and loading of the last loaded effect. If this sequence does not occur, contact Lexicon Customer Service.

You can restore the PCM 90 to its default state *without* erasing registers by restoring the factory default setup:

Restoring Factory Default Settings

1. Press **Control**.
2. Use the **Up** and **Down** buttons to locate **Row 4 Setup**.
3. Turn SELECT to **4.1 Load**.
4. Turn ADJUST counterclockwise to select "Factory Settings".
5. Press **Load/★**. The PCM 90 will display the message "Setup restored".

The following table shows the parameters which comprise a setup, along with the factory default setting of each parameter.

Control Mode			
Matrix Location		System Parameter	Default Setting
Audio	0.0	Input Source	Analog: 48kHz
	0.1	SCMS	Multi Copy
	0.2	Emphasis Bit	Pass Thru
	0.3	Output Level	+4dBu
System	1.0	Edit Mode	Go
	1.1	Mix Mode	Pgm
		Global Mix Value	100% Wet
	1.2	Tempo Mode	Pgm
		Global Tempo Value	120 BPM
	1.3	Bypass Mode	InputMute
		Bypass Src	Off
	1.4	Pgm Bypass	AllMute
	1.5	Mem Protect	Off
	1.6	Auto Load	Off
1.7	Patch Update	Delayed	
1.8	KeyWord	On (A to Z)	
MIDI	3.1	Receive	OMNI
	3.2	Transmit	1
	3.3	Pgm Change	On
		Pgm+	Off
		Pgm-	Off
		Map select	0
		Chain	MIDI
	3.4	Automation	Off
	3.5	Footpedal	None
		Sw 1	None
		Sw 2	None
		ADJUST	None
		Custom 1-4	None
3.6	Int Clock	Transmit Off	
	SysEx	Receive On	
3.7	Device ID	0	
	MIDI Dump	Current Program	
3.8	MIDI Dump	Current Program	
3.9	Dump Speed	Slow	
Tempo Mode			
Matrix Location		System Parameter	Default Setting
Tempo	0.2	Source	Internal
Tap	1.3	Display	On

Reinitialization

Reinitializing will erase all registers and setups

The following procedure will return the PCM 90 to the state it was in when shipped from the factory. This includes erasing all registers and setups, as well as restoring all of the default settings:

1. Press **Control**.
2. Use the **Up** and **Down** buttons to locate **Row 1 System**.
3. Turn SELECT to **1.9 Initialize**.
4. Press **Store**. The PCM 90 will display the message "Are you sure? (Press STORE)".

If you don't want to reinitialize your unit, press any button *except Store* to return to matrix position **1.9**.

If you press **Store** in response to this message, the display will flash "Restoring original factory settings" and your unit will be reinitialized.

PCM 90 Specifications

Audio Input	Connectors:	Combined 3 pole XLR and 1/4 inch T/R/S phone jacks (2)
	Impedance:	0 dB/BAL switch position: 100k Ω , balanced -20 dB/UNBAL switch position: 50k Ω , unbalanced
	Levels:	0 dB/BAL switch position: -2 dBu min for full scale, +20 dBu max -20 dB/UNBAL switch position: -22 dBu min for full scale, 0 dBu max
	CMRR:	0 dB/BAL switch position: 40 dB minimum, 10 Hz to 20 kHz
Audio Output	Connectors:	1/4 inch T/R/S phone jacks (2); balanced XLRs, pin 2 "high" (2)
	Impedance:	125 Ω , each side, balanced
	Levels:	+18 dBm max, full scale (+4 dBu setting) balanced, unbalanced +4 dBm max, full scale (-10 dBu setting)
	Protection:	Relays provided for output muting during power on/off
A/D Performance	Frequency Response:	10 Hz to 20 kHz, ± 0.5 dB
	Crosstalk:	-65 dB max, 10 Hz to 20 kHz
	S/N Ratio:	100 dB min, 20 kHz bandwidth
	THD:	0.004% max, 10 Hz to 20 kHz
	Dynamic Range:	100 dB min, 20 kHz bandwidth
	Delay:	24 samples (0.54 msec for 44.1 kHz, 0.50 msec for 48 kHz)
D/A Performance	Frequency Response:	10 Hz to 20 kHz, ± 0.5 dB
	Crosstalk:	-80 dB max, 10 Hz to 20 kHz
	S/N Ratio:	100 dB min, 20 kHz bandwidth
	THD:	0.006% max, 10 Hz to 20 kHz
	Dynamic Range:	>95 dB, 20 kHz bandwidth
	Delay:	50 samples (1.13 msec for 44.1 kHz, 1.04 msec for 48 kHz)
A/A Performance	Frequency Response:	10 Hz to 20 kHz, ± 0.5 dB
	Crosstalk:	-55 dB max, 10 Hz to 20 kHz
	S/N Ratio:	90 dB min, 20 kHz bandwidth
	THD:	0.008% max, 10 Hz to 20 kHz
	Dynamic Range:	>94 dB, 20 kHz bandwidth

Digital Audio Interface	Connectors:	Coaxial, RCA type
	Format:	conforms to S/PDIF CP-340 Type II and IEC-958 consumer standards
	Sample Rates:	44.1 kHz, 48 kHz
Internal Audio Data Paths	Conversion:	18 bits
	DSP:	18 to 24 bits
Audio Memory Configuration	Base memory:	Two 256k x 18 DRAMs
External Memory Card	Connector:	Accepts PCMCIA Type I cards, 68 pins
	Standards:	Conforms to PCMCIA 2.0 / JEIDA 4.0
	Card Format:	Supports up to 1MB SRAM (attribute memory not required)
Control Interface	MIDI:	5-pin DIN connectors provided for MIDI IN, THRU, & OUT
	Footswitch:	1/4 inch T/R/S phone jack provided for 2 independent momentary footswitches System detects normal-open, or normal-closed on power up
	Foot controller:	1/4 inch T/R/S phone jack provided for footpedal (100Ω minimum, 10kΩ maximum impedance)
General	Dimensions:	19.0"W x 1.75"H x 12.0"D (483 x 45 x 305 mm) 19 inch rack mount standard, 1U high
	Weight:	Net: 6.4 lbs (2.9 kg) Shipping: 9.5 lbs (4.3 kg)
	Power Requirements:	100-240 VAC, 50-60 Hz, 35 W, 3-pin IEC power connector
	RFI/ESD:	Conforms to FCC Class B, EN55022 Class B (CE), IEC 801-2, IEC 801-3
	Environment:	Operating temperature: 32° to 104°F (0° to 40°C)
		Storage temperature: -22° to 167°F (-30° to 70°C) Humidity: maximum 95% without condensation

Unless otherwise noted, all audio specifications assume rear-panel switch set to BAL, input level control is set for unity gain (0dB), and analog I/O connections wired for balanced configuration.

Specifications subject to change without notice.

Lexicon

■ A Harman International Company

3 Oak Park
Bedford, MA 01730 USA
Tel 781-280-0300
Fax 781-280-0490
Customer Service Fax 781-280-0499
www.lexicon.com

Lexicon Part # 070-10399 Rev 1